

Sensors & System Solutions  
Metallic Flat & Long Products



More Precision





"Micro-Epsilon supplied a system tailored to our needs, which has now been in virtually trouble-free service for 15 years to our complete satisfaction. We appreciate their fast and effective technical support whenever we need assistance."

*Hans-Joerg Herrmann, Aluminium Norf GmbH*



"As a supplier, Micro-Epsilon has been great. They've also provided technical support when required and delivered a system that does exactly what we want it to do."

*Andy Spalding, Liberty Speciality Steels*

Micro-Epsilon has been a reliable industrial partner for more than 50 years in precision measurement technology for inspection, monitoring and automation. Micro-Epsilon systems and sensors are used in numerous measurement tasks by users in metal production and metal processing in order to make production efficient.

The extensive product portfolio meets the highest requirements and delivers high signal stability even in highly dynamic processes. The range of applications extends from metal production through hot and cold rolling mills to process lines.

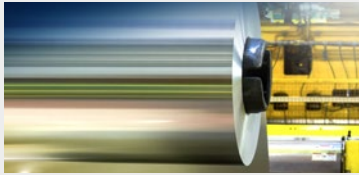

Steel production ..... 4 - 5

Hot rolling of flat products ..... 6 - 9

Hot rolling of long products ..... 10 - 11

Molding rollers for long products ..... 12 - 13

Cold rolling of flat products ..... 14 - 15

Coating lines ..... 16 - 17

Service centers & Shearing lines ..... 18 - 21

Predictive maintenance &  
Quality assurance ..... 22 - 23

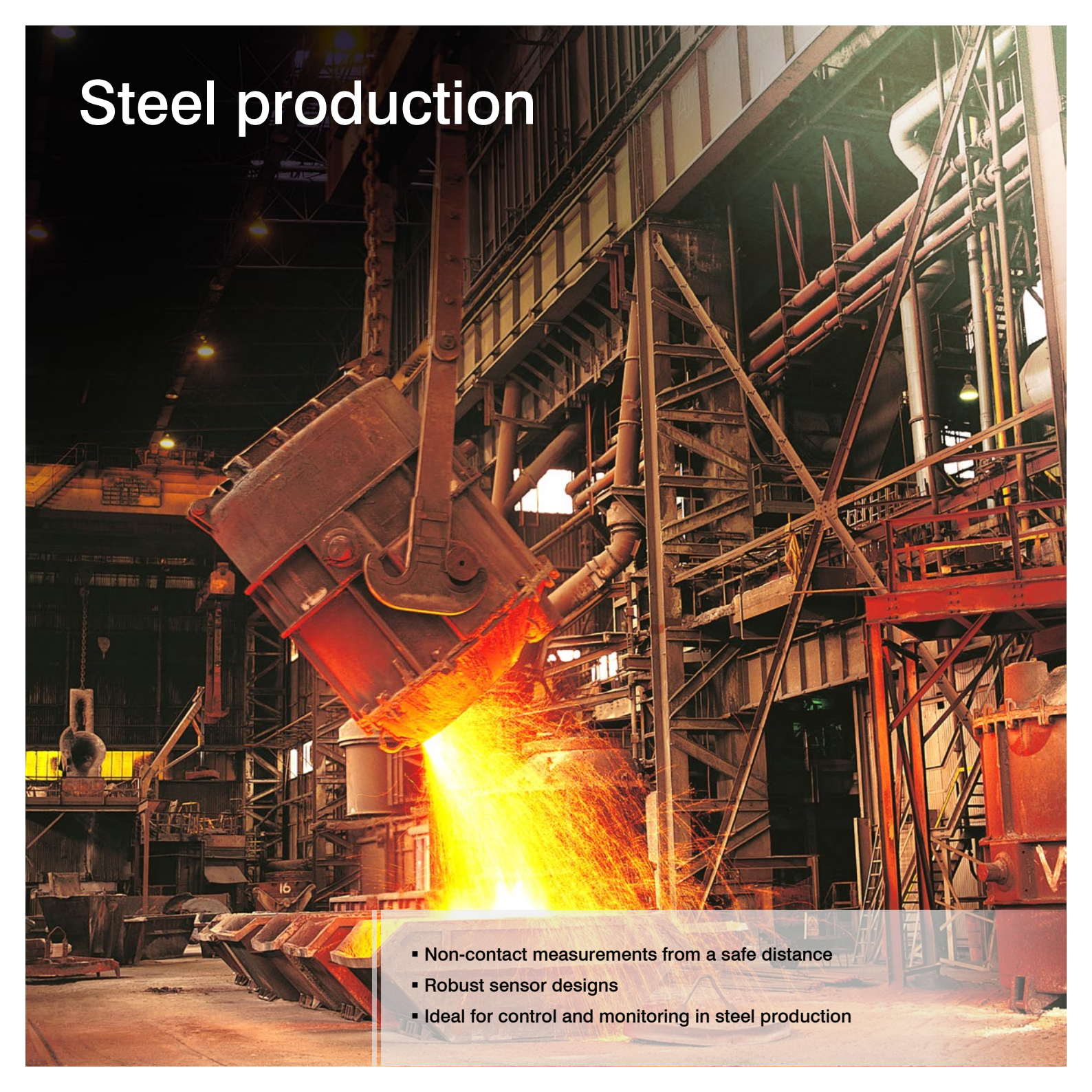

# Steel production

- 
- Non-contact measurements from a safe distance
  - Robust sensor designs
  - Ideal for control and monitoring in steel production



### Non-contact infrared temperature measurements in steel production

Temperature is an important process variable in steel production. Adhering to predetermined process temperatures ensures, amongst other things, high product quality. Providing reliable and reproducible measurement results, particularly in high temperature processes, non-contact infrared temperature measurement from Micro-Epsilon has become well established in the metal production and processing industry. Infrared temperature sensors from Micro-Epsilon are frequently used for monitoring and control purposes in metal production processes. Numerous models, equipment options and a comprehensive interface concept enable their fast and easy integration in different measuring positions.

Sensor: *thermoMETER CTM2/M3*



Temperature measuring range  
up to 1600 °C



Temperature monitoring during  
cooling of forged parts

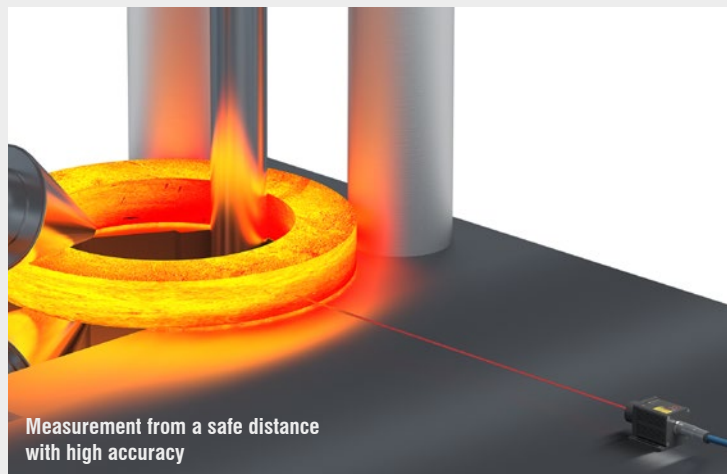

Measurement from a safe distance  
with high accuracy

### Diameter measurement of rings during rolling

In ring rolling, stainless steel or titanium are seamlessly formed into large rings at temperatures of up to 1100 °C. For this purpose, the red-hot blank is placed in the ring rolling mill. The diameter of the ring increases continuously due to the rolling process, which must be continuously monitored. Conventional sensors that are mounted close to the measuring object cannot withstand the high temperatures, flaking scale and steam. Therefore, precise measurements are required from a great distance where the optoNCDT ILR2250-100 laser distance sensors are used. The sensor is mounted at a safe distance of up to 10 m and measures the distance to the rolled material during rolling.

Sensor: *optoNCDT ILR*

# Hot rolling of flat products

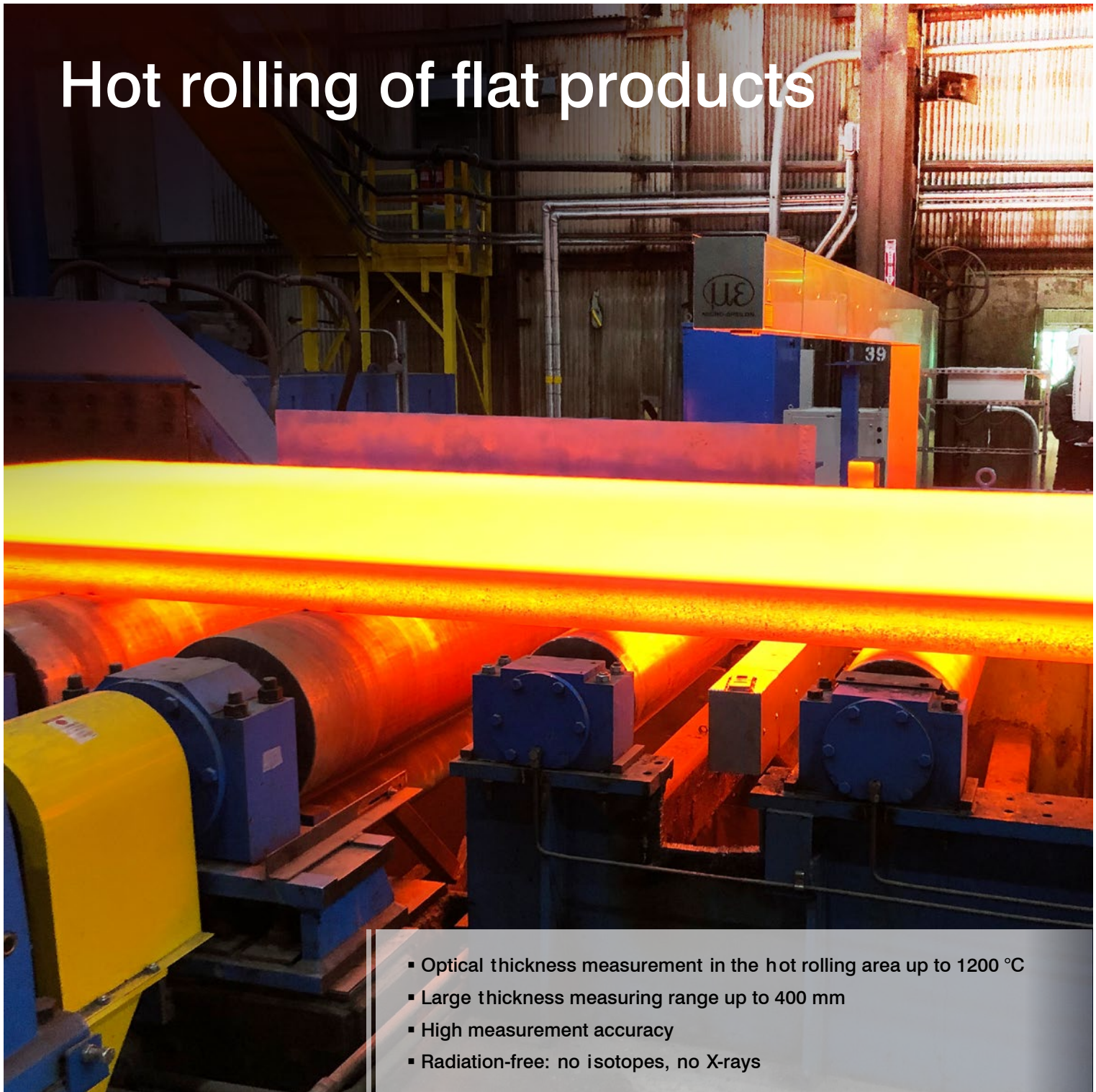

- Optical thickness measurement in the hot rolling area up to 1200 °C
- Large thickness measuring range up to 400 mm
- High measurement accuracy
- Radiation-free: no isotopes, no X-rays



### Optical thickness measurement in rolling mills

The new generation of thicknessCONTROL thickness gauges stands for exceptional performance and overcomes the challenges of one of the most difficult applications for optical thickness measurements. The systems are designed for use in hot rolling mills and are resistant to harsh environmental conditions. In different operating modes, these measuring systems provide results with the highest precision.

### Patented technology for red-hot glowing objects

The systems are equipped with innovative Blue Laser sensors. The internationally patented measuring procedures for Blue Laser Technology allow precise measurements to be made on red-hot glowing objects above 700 °C.

### Intelligent measuring mechanics for high temperatures

The thicknessCONTROL mechanics are designed to partially compensate for changes induced by temperature gradients. In addition, a network of temperature sensors controls the state and stabilizes the measuring range using powerful signal processing. An additional, regulated cooling register and deflector plates even enable use in steel hot rolling mills at material temperatures of 1200 °C.

*Thickness measuring system: thicknessCONTROL*

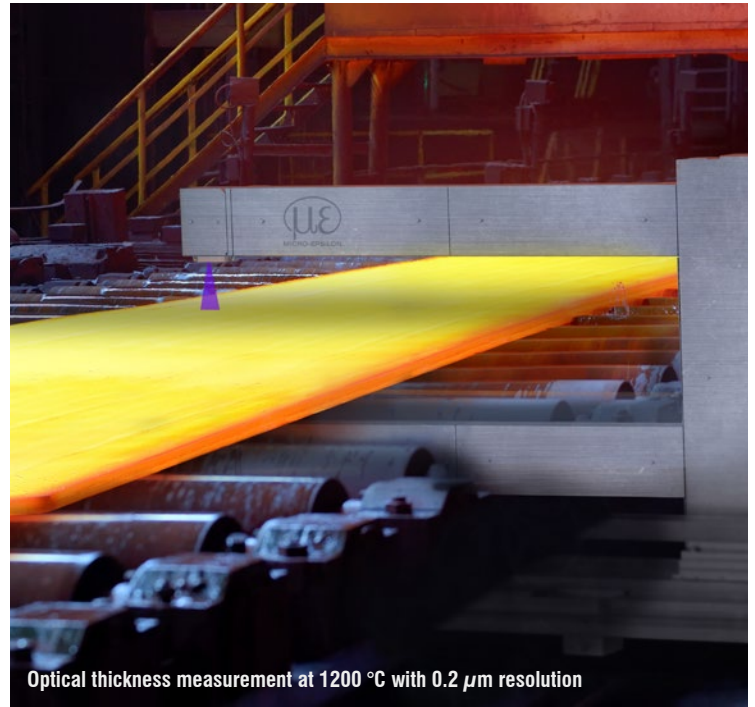

### thicknessCONTROL MTS 9202

The MTS 9202 systems are designed as C-frames and impress with their extremely high precision and flexible use in thickness measurements. They perform the measurement either in traversing mode or directly at a measuring point.

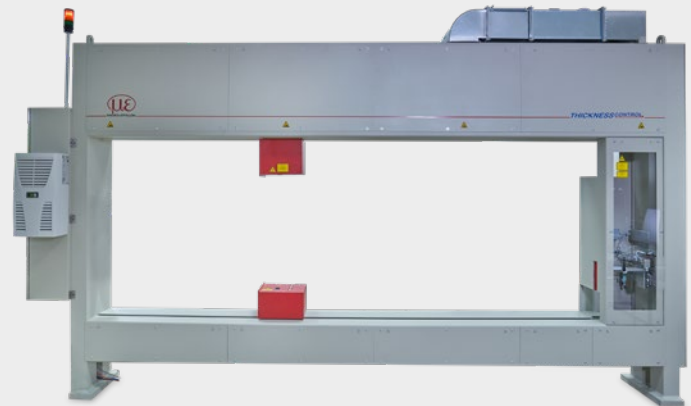

### thicknessCONTROL MTS 9201

The MTS 9201 systems are designed as O-frames and impress with their stability and extremely high precision in thickness measurement, especially for large material widths. In hot rolling mills, they provide reliable measurement results with the highest precision and ensure the specified quality in production and safe process control.

# Hot rolling of flat products

- Ideal for control and monitoring in the hot rolling area
- Non-contact measurements from a safe distance
- Early detection of defects and deviations





### Thickness measurement of slabs during rough rolling

In order to monitor the slab thickness during the first rolling processes, laser distance sensors are used which measure from above onto the rolled material. Due to the high temperatures, steam and emulsions, measurement from a long distance is required, for which optoNCDT ILR2250 laser distance sensors are used. The sensors determine the thickness from the difference between the rolling mill and the slab on top.

Sensor: *optoNCDT ILR2250*

### Thermal imaging cameras for non-contact temperature measurement during hot rolling

Thermal imaging cameras are particularly well suited to the control and condition monitoring of processes and of semi-finished parts. They measure from a safe distance to the measuring object, record temperature values and can be directly integrated into the control system. The thermoIMAGER TIM M1 from Micro-Epsilon is an extremely compact infrared camera for non-contact temperature measurement of metal surfaces. Their short-wave range enables the cameras to reliably measure the temperature of hot metal surfaces.

In parallel to the visualization of a thermal process, powerful electronics ensures fast response times of 1 ms to output the temperature information of the center pixel. Therefore, the camera can also be used for integration into control systems.

Sensor: *thermoIMAGER M1*

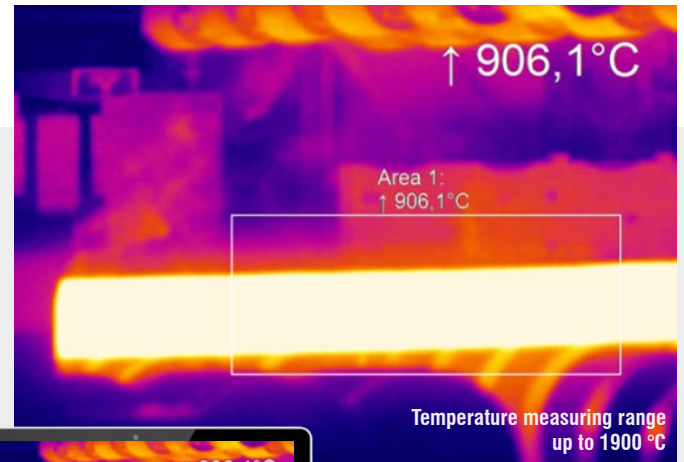

# Hot rolling of long products



- True 3D measurement of profiles
- Non-contact measurement with high accuracy
- Ideal for monitoring and process control



Precise distance measurement with patented Blue Laser Technology

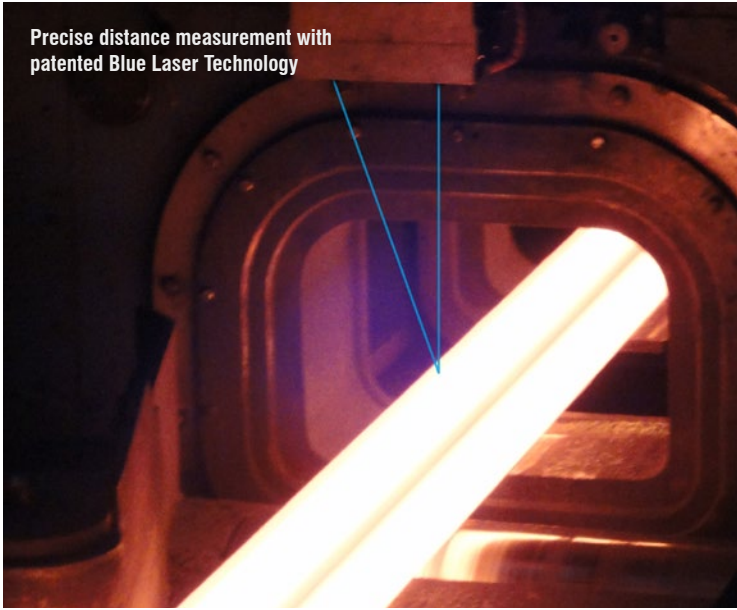

### Inspecting the longitudinal profile of shaped steels

In section rolling mills, shaped steels are usually rolled in reversing operation. After the hot rolled bars (up to 1200 °C) have left the rolling stand, they are checked for dimensional accuracy. Here, Blue Laser sensors measure the rod center at material speeds of up to 10 m/s. The optoNCDT1750-750BL is equipped with the patented Blue Laser Technology and measures reliably on glowing objects. Special optical filters block out the intrinsic radiation of the glowing target. Thanks to the large measuring range, different geometries of the rolled products can be reliably detected with only one sensor.

Sensor: optoNCDT 1750BL

### 3D Profile measuring systems for long products

The MPG 8208 systems are designed as horseshoe frames and are individually integrated into the line. Inside the frame are six laser line triangulation sensors and a fully automated calibration system. The lasers project straight lines onto the surface to be measured. These lines are deformed from the camera's point of view. The basic calibration of the sensor serves as a reference to convert the deviation into concrete measured values. In demanding environmental conditions such as heat, the sensor system is protected from environmental influences by complex integrated cooling systems.

Profile measuring system: dimensionCONTROL MPG 8208

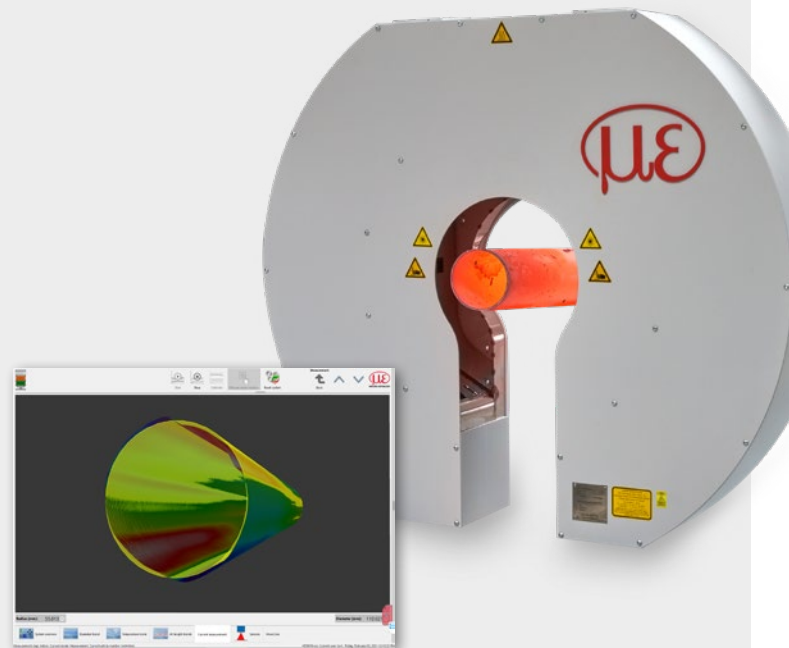

# Molding rollers for long products

- True 3D measurement of profiles
- Non-contact measurement with high accuracy
- Ideal for monitoring and process control



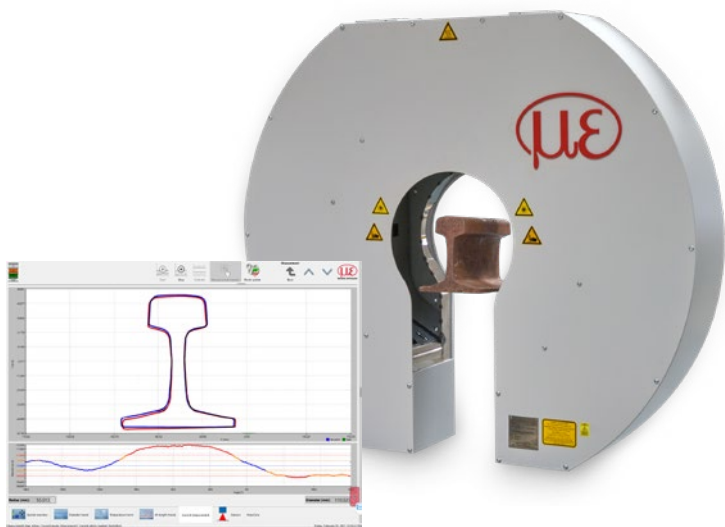

### 3D Profile measuring systems for long products

The MPG 8208 systems are designed as horseshoe frames and are individually integrated into the line. Inside the frame are six laser line triangulation sensors and a fully automated calibration system. The lasers project straight lines onto the surface to be measured. These lines are deformed from the camera's point of view. The basic calibration of the sensor serves as a reference to convert the deviation into concrete measured values.

*Profile measuring system: dimensionCONTROL MPG 8208*

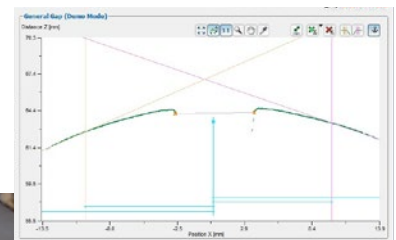

### Gap measurement in forming lines

Before welding pipes, the gap is monitored with laser scanners. The scanners provide precise readings, allowing the position of the center point to be output. In this way, the pipe is brought into the optimum position relative to the welding head. Thanks to the high profile frequency of the scanner, dynamic processes can also be monitored.

*Sensor: scanCONTROL 3000*



*X-Frame*

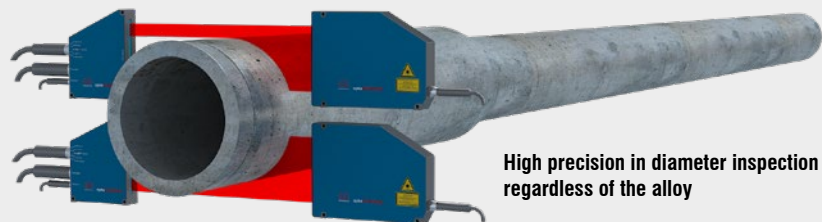

**High precision in diameter inspection regardless of the alloy**

### Measurement of the diameter of profiles

Optical micrometers from Micro-Epsilon are used to monitor the thickness of metal bars. With the X-Frame measuring system the diameter is measured continuously. Two laser micrometers measure the diameter with high resolution and measuring rate. The X-Frame enables the measurement of different thicknesses, and digital interfaces transmit the data to the higher-level control system.

*Sensor: optoCONTROL 2520*

# Cold rolling of flat products

A photograph of a cold rolling mill. A large, shiny metal roll is being processed. The background shows industrial machinery and a yellow safety railing. The image is slightly blurred to convey motion.

- Non-contact measuring procedures
- Reliable measurement even on shiny surfaces
- Submicron accuracy



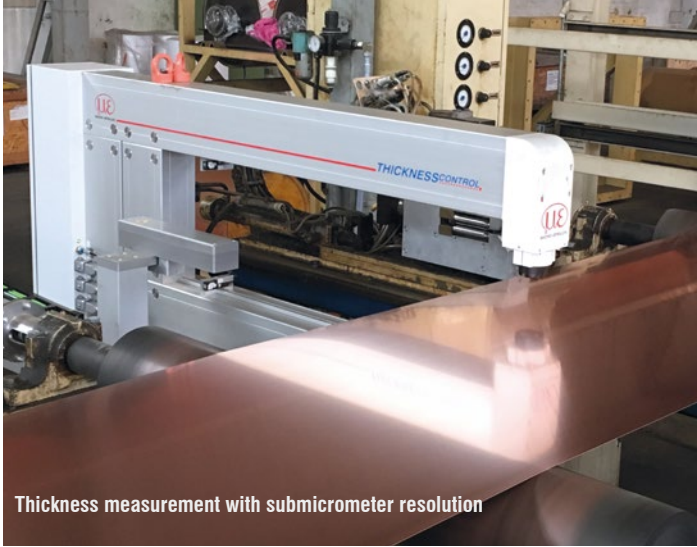

### Optical thickness gauges for flat products

thicknessCONTROL MTS 8202 systems are used for process-reliable thickness measurement in cold rolling mills. Measurements are also possible on reflective and shiny surfaces, e.g., copper strip, coated metal and high-gloss aluminum. For these measurements, the systems are equipped with confocal sensors that also measure reliably on changing surfaces. The measurement is carried out without contact and thus reaction-free, so that even sensitive materials can be measured reliably. The high measuring rates also allow for dynamic processes to be detected reliably.

*Thickness measuring system: thicknessCONTROL 8202.K*

### Non-contact temperature measurement in the rolling line

In the rolling line, the forming temperature between the individual rolls is measured continuously. The aim is to optimize processes and ensure quality. For the measurement of the sheet metal temperature, a fast pyrometer is recommended as it is ideally suited to measurements under harsh environmental conditions.

*Sensor: thermoMETER CTM2/M3*



# Coating lines



- Reliable measurement methods for all coating processes
- Non-contact measurement with high accuracy
- Ideal for process control



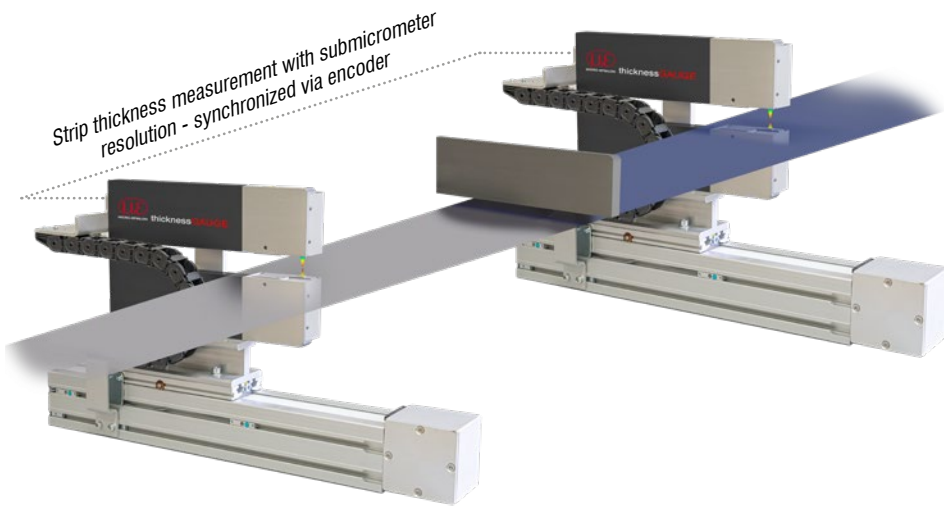

### Coating thickness measurement with two synchronized thickness measurements

Two synchronized thicknessGAUGE systems are used for precise thickness measurement in coating processes. One system records the strip thickness before coating and one system monitors the thickness after the coating is applied. The coating thickness is determined from the difference between the two measured values and transferred to the system controller. The systems are equipped with confocal sensors that achieve high measurement accuracy independent of the surface reflection.

*Measuring system: thicknessGAUGE.confocal*

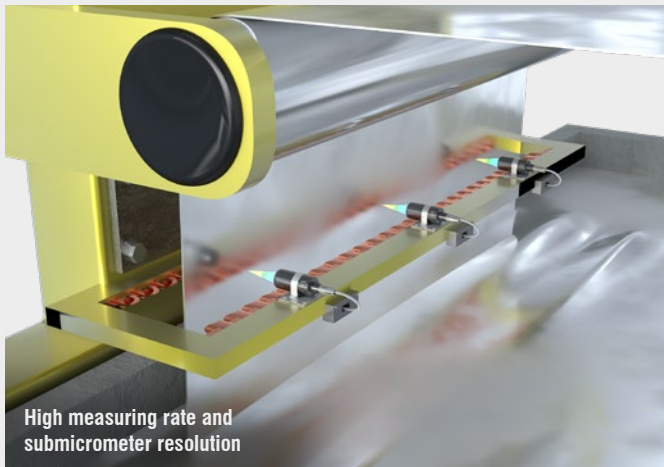

### Distance control of air scraper nozzles in galvanizing lines

For corrosion protection, a protective layer of zinc is applied to the metal strip. To do this, the steel strip is passed through a zinc basin, which causes a thin layer of zinc to adhere. The applied zinc is evenly distributed and smoothed by air scraper nozzles. In order to achieve the desired thickness, precise distance control of the air nozzles is required. confocalDT sensors are used to measure the nozzle distances. They enable precise distance measurements on highly reflective surfaces. Thanks to the high measuring rate, the distance between the air scraper nozzles is detected and readjusted with high dynamics.

*Sensor: confocalDT*

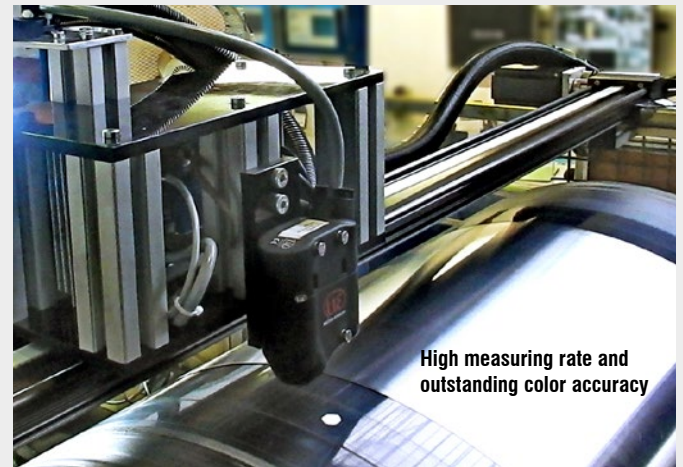

### Color measurement on coated metal strips

When coating steel, titanium and aluminum, metal strips not only receive protection against corrosion and wear, but also a defined color. The color shade is inspected in strip systems after they have gone through a coating process. Due to the high requirements in terms of accuracy and dynamics, colorCONTROL ACS7000 is used in this application. This color spectrometer is ideal for integration into processing lines while offering excellent color accuracy, different interfaces for integration purposes and high measurement speed.

*Sensor: colorCONTROL ACS7000*

# Service centers & Shearing lines



- Measure width, thickness and cambering with only one system
- C- and O-frame systems with innovative optical measuring methods
- Precise measurement results for control, quality assurance and documentation



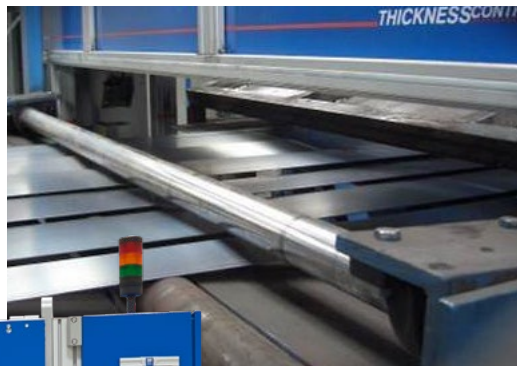

Thickness and width measurement of individual rings after a slitting shear

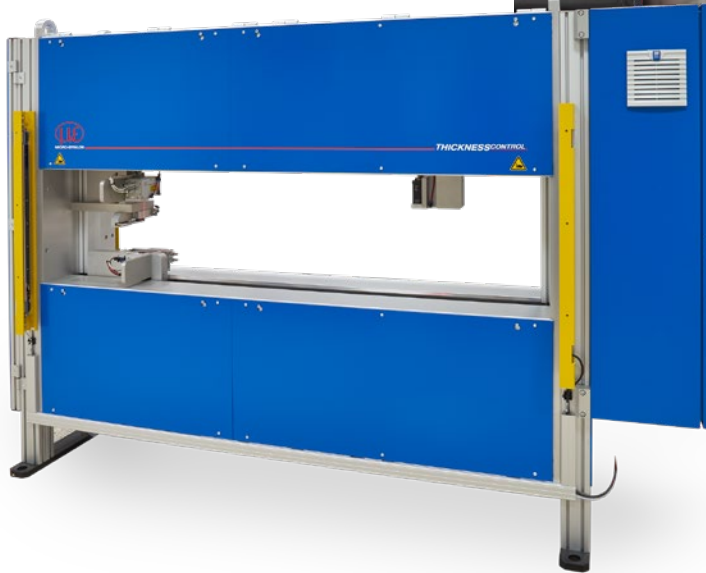

### Thickness and width measurements of metal strips

thicknessCONTROL MWS 8201.LLT combines thickness and width measurements in one O-frame system equipped with three laser line sensors. Two sensors are integrated in the upper belt and one sensor in the lower belt. While the sensors continuously detect the thickness profile while being traversed, the width is always measured when both sensors are positioned in the upper belt on one edge. This system architecture is suitable for monitoring and process optimization of slitting lines, as the thickness and width can be continuously monitored and documented for each individual ring. The third laser scanner is moved independently of the two scanners for thickness measurement and can measure the exact width of individual rings in slitting lines.

*Measuring system: thicknessCONTROL MWS 8201.LLT*

### Measurement of width, cambering and diameter of metal strips

thicknessCONTROL C-frame systems are used for the precise determination of width, cambering and diameter of metal strips in shearing lines. These are equipped with three laser micrometers and detect the cambering when the strip stops. The width measurement is taken during operation whilst the C-frame traverses over the metal belt.

*Measuring system: thicknessCONTROL*



High measurement accuracy regardless of the alloy

# Service centers & Shearing lines



- Smart sensors with integrated controller
- Inline measurement of edge and burrs with micrometer accuracy
- Ideal for quality inspection and process control



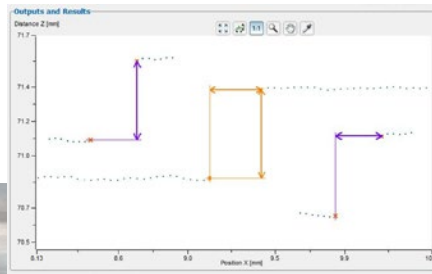
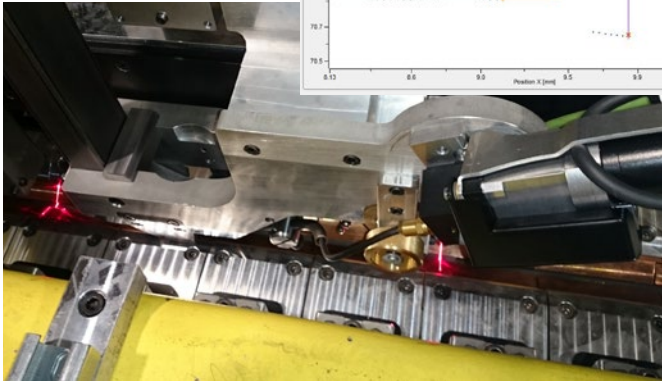

### Sheet edge measurement with laser welding

Automated robotic welding cells monitor the quality of pipes with longitudinal welding on the basis of several points. On the one hand, the edge position must be known along the sheet edge length while also ensuring the optimal alignment of the sheet edge. Laser scanners from Micro-Epsilon which process several measurement programs in the integrated controller are used for monitoring. The scanCONTROL SMART sensors require no additional controller, which considerably simplifies the installation procedure.

*Sensor: scanCONTROL SMART*



### Checking the knife position when trimming metal strips

Edge trimming is often required for the further processing of metal strips. If the width of the metal strip is changed, the knives automatically move to the new working position. Laser sensors from Micro-Epsilon are used for non-contact monitoring of the knife position, which measure the distance to the knife drives. With the use of the optoNCDT 1900, the knife position is reliably monitored and controlled fully automatically.

*Sensor: optoNCDT 1900*

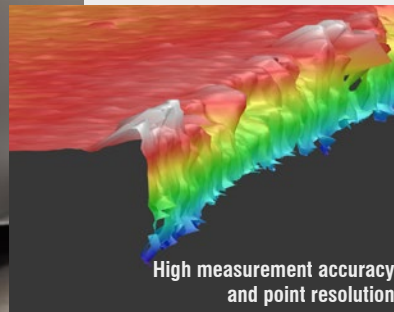
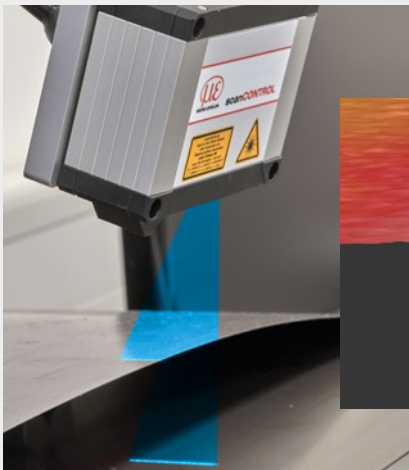

### Burr measurement in slitting lines

The cutting process causes burrs to form on the cut surfaces of the metal strips. For inline monitoring of the burr, scanCONTROL laser scanners are used, which permanently monitor the sheet edges. Thanks to the Blue Laser Technology, precise measurement values with high signal stability are determined. Limit value transgressions are transferred directly to the control system, allowing the slitting process to be adjusted, e.g., by servicing the knives or adjusting the path control.

*Sensor: scanCONTROL*

# Predictive maintenance Goods inwards inspection

A large industrial roll of metal, possibly aluminum or steel, is the central focus of the image. The roll is positioned horizontally and is partially unrolled, showing the texture of the metal. The background is a blurred industrial environment with blue and yellow structural elements, suggesting a factory or manufacturing plant. The lighting is dramatic, with a strong light source from the left creating a bright highlight on the metal surface.

In addition to tasks in strip and rolling processes, sensors from Micro-Epsilon solve a wide range of other measurement tasks. Contact us and let's find the best solution for your measurement task.



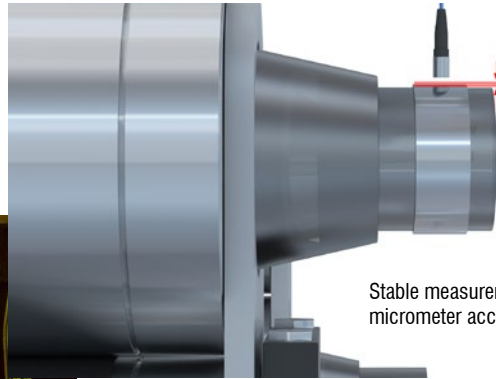

Stable measurement with micrometer accuracy



### Measurement of roll wear in the roll stand via the bearing gap

Capacitive displacement sensors are used to determine the wear of rollers. The roll wear is measured indirectly via the change in the bearing gap of the drive shaft. Thanks to the capacitive sensors, the measurement is continuous and with high precision. As a result, wear is permanently determined and detected at an early stage, which means that maintenance intervals can be scheduled in a targeted manner. The capacitive sensors can also be used with strong temperature fluctuations and provide a high signal stability.

*Sensor: capaNCDT*



### Non-contact detection of the coil diameter

When unwinding coils, continuous detection of the coil diameter is necessary in order to determine the changeover time at an early stage. Therefore, optoNCDT ILR2250 laser distance sensors are used to monitor the unwinding process by detecting the distance to the coil. Unwinding the coil continuously reduces the diameter. Consequently, the distance between coil and sensor increases. The sensor reliably detects this change in distance and transmits it as a measurement value to the control system involved in the production process.

*Sensor: optoNCDT ILR2250*

Reliable distance measurement with high accuracy

## Sensors and Systems from Micro-Epsilon



Sensors and systems for displacement, distance and position



Sensors and measurement devices for non-contact temperature measurement



Measuring and inspection systems for metal strips, plastics and rubber

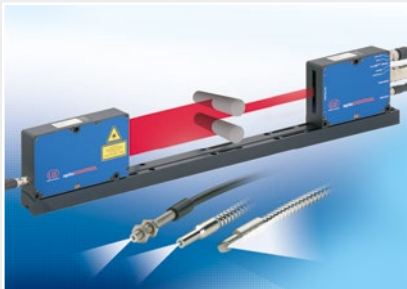

Optical micrometers and fiber optics, measuring and test amplifiers



Color recognition sensors, LED analyzers and inline color spectrometers



3D measurement technology for dimensional testing and surface inspection

## More Precision

Whether it is for quality assurance, predictive maintenance, process and machine monitoring, automation or R&D – sensors from Micro-Epsilon make a vital contribution to the improvement of products and processes. High precision sensors and measuring systems solve measurement tasks in all core industries – from machine building to automated production lines and integrated OEM solutions.



MICRO-EPSILON

[www.micro-epsilon.com](http://www.micro-epsilon.com)