

## Proper Environment

- Protection class sensor: IP67 (Only with connected supply/output cable)  
The degree of protection does not apply for optical inputs as their pollution causes damage or failure of the function.  
The protection class is limited to water (no penetrating liquids or similar).
- Temperature range:
  - Operation: 0 ... +50 °C (+32 ... +122 °F)
  - Storage: -20 ... +70 °C (-4 ... +158 °F)
- Humidity: 5 ... 90 % (non-condensing)
- Pressure: Atmospheric pressure

## Laser Safety

The optoCONTROL 120x light source operates with a semiconductor laser with a wavelength of 670 nm (visible/red). the maximum optical power is  $\leq 0.39$  mW.

The sensors fall within laser class 1.

The accessible radiation is harmless under predictable conditions. For class 1 laser devices, impairment of color vision and disturbances, e.g., from a glare effect, cannot be excluded.

Consequently, you can use Class 1 laser equipment without further protective measures.

Lasers of Class 1 are not subject to notification and a laser protection officer is not required.

The following laser warning labels must be attached to the cover (front side):

The laser warning labels for Germany are included in delivery and the versions valid for the users' country must be attached before the device is put into operation for the first time. For other non German speaking countries, an IEC and USA standard label has already been attached and enclosed in addition.

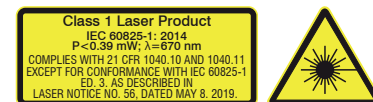

Laser label and laser warning sign, IEC and USA

Laser label and laser warning sign, Germany

The housing of the receiver and the light source may only be opened by the manufacturer, see 8. For repair and service purposes, the sensors must always be sent to the manufacturer.

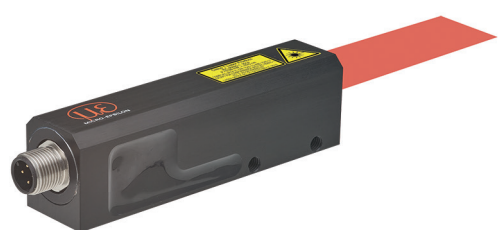

Fig. 1 Sensor ODC1200 with laser labels

## Installation and Assembly

The optoCONTROL 120x sensor is an optical system used to measure in the mm range.

Ensure careful handling during installation and operation.

## Dimensional Drawings

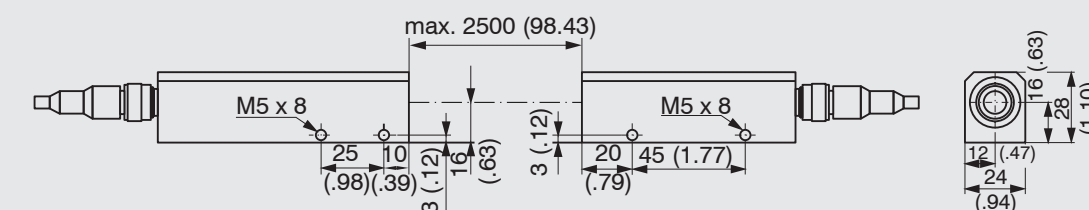
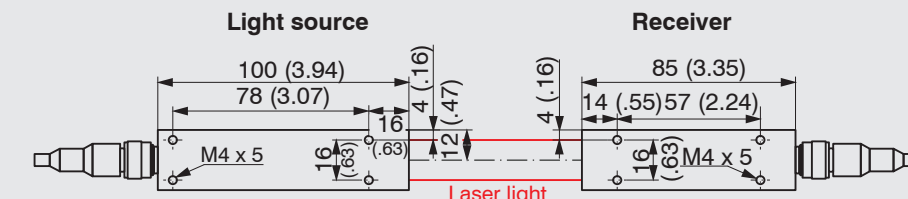

Dimensional drawing ODC 1200, measuring ranges 2/5/10/16 mm, dimensions in mm (inches)

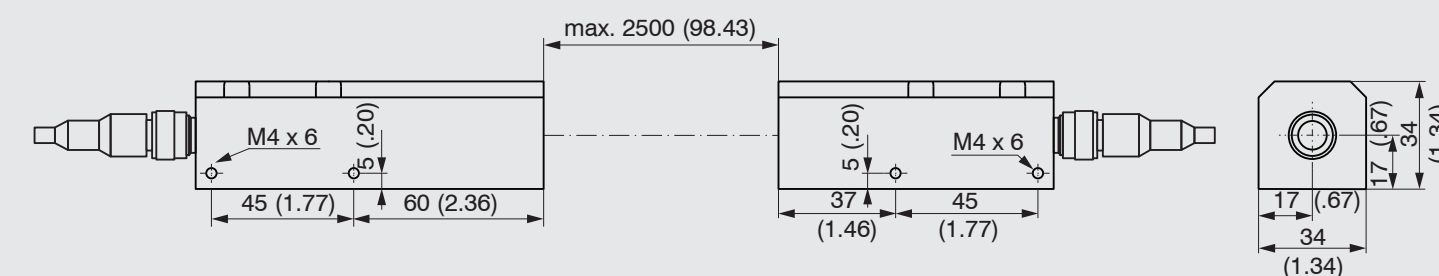
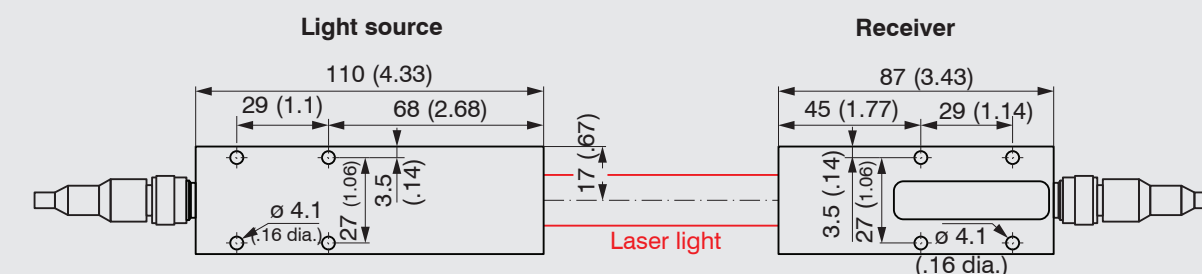

Dimensional drawing ODC 1201, measuring ranges 20/30 mm, dimensions in mm (inches)

Do not touch the optical windows.

> Functionality impaired due to contamination

No sharp or heavy objects should be allowed to affect the cables. Avoid folding the cables.

> Damage or destruction of the cable, failure of the measuring device

Do not bend the cables more tightly than 52 mm.

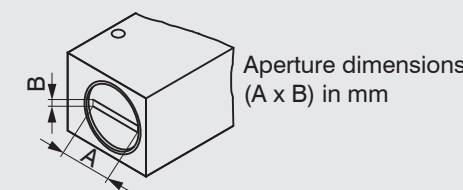

Model	Light source	Receiver
ODC1200-2	2 x 2	2 x 0.3
ODC1200-5	5 x 2	5 x 0.3
ODC1200-10	10 x 2	10 x 0.3
ODC1200-16	16 x 2	16 x 0.3

Model	Light source	Receiver
ODC1201-20	20 x 2	20 x 0.3
ODC1201-30	20 x 2	30 x 0.3

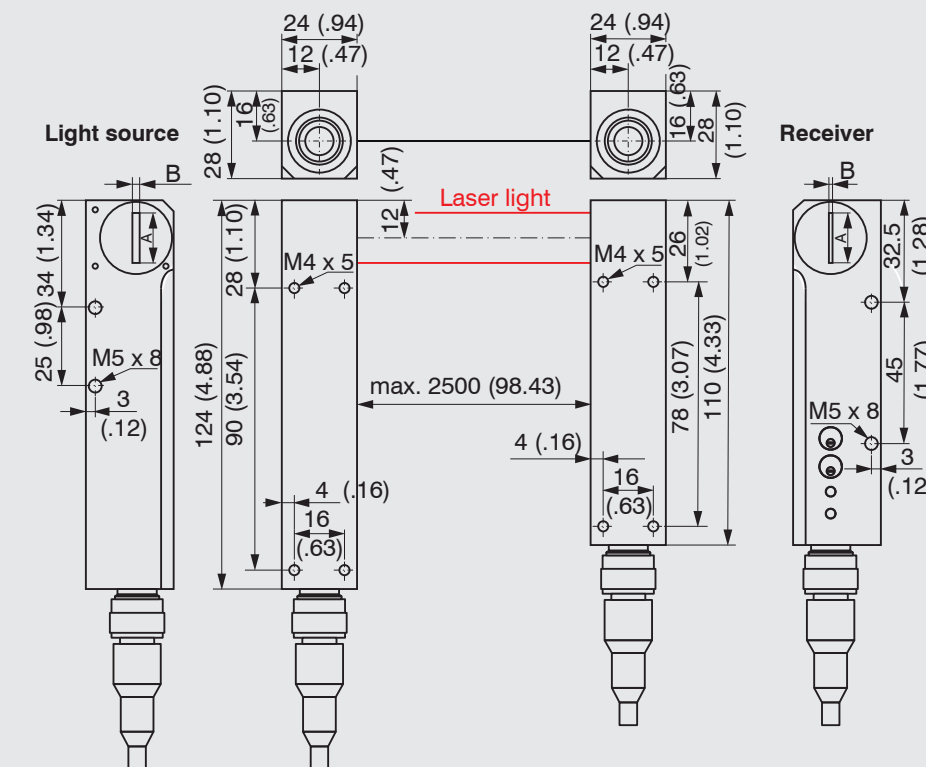

Dimensional drawing ODC 1200/90, measuring ranges 2/5/10/16 mm, dimensions in mm (inches)

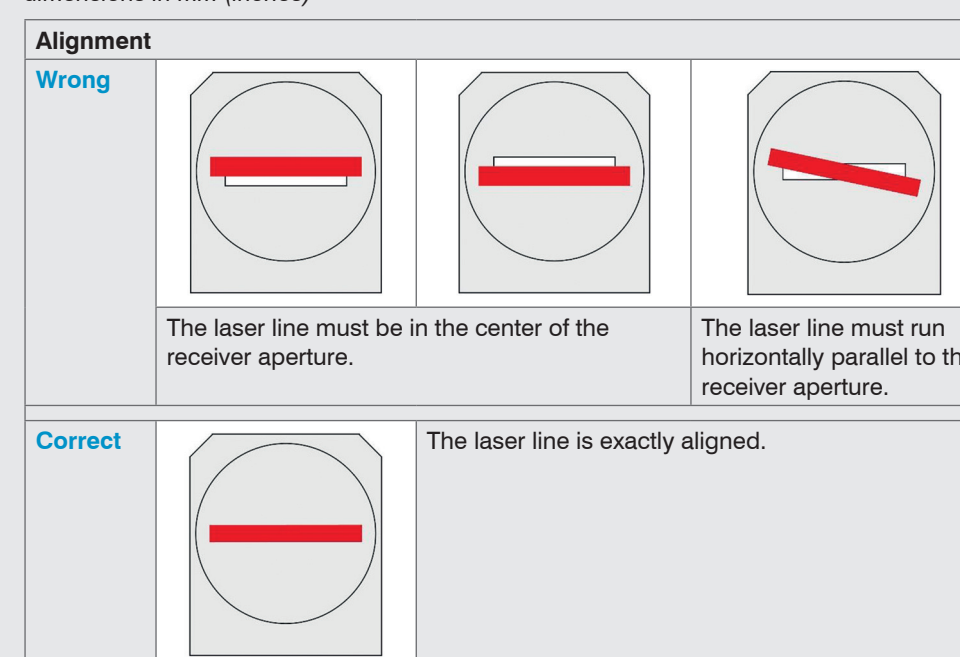

Model	Light source	Receiver
ODC1200/90-2	2 x 2	2 x 0.3
ODC1200/90-5	5 x 2	5 x 0.3
ODC1200/90-10	10 x 2	10 x 0.3
ODC1200/90-16	16 x 2	16 x 0.3

Aperture dimensions (A x B) in mm

## Sensor Mounting

Mount the sensor only to the existing holes on a flat surface. Clamps of any kind are not permitted.

> Inaccurate, erroneous measuring values

The sensor is mounted by means of screws type M4 or M5.

When the sensor components (light source and receiver) are mounted, initially exact alignment with respect to one another should be ensured. Adjust the light curtain exactly to the receiver aperture.

A stop bracket or rails are suitable tools for alignment.

Optical and mechanical axis are not identical, especially with distances > 150 mm (between transmitter and receiver), an adjustment possibility in 3 axes shall be provided. To align the laser beam properly onto the receiver aperture, please use the JU1200-xx adjustment plate (optional accessories).



## Assembly Instructions optoCONTROL 1200/1201

## Intended Use

The optoCONTROL series 1200/1201 is designed for use in industrial areas. It is used for measuring diameters, gaps, edges and light quantity.

The system must only be operated within the limits specified in the technical data, Chap. 3.3.

The system must be used in such a way that no persons are endangered or machines and other material goods are damaged in the event of malfunction or total failure of the system. Take additional precautions for safety and damage prevention for safety-related applications.

## Warnings

Connect the power supply and the display output device according to the safety regulations for electrical operating equipment.

> Risk of injury, Damage to or destruction of the sensor

Avoid shocks and impacts to the light source and receiver. The supply voltage must not exceed specified limits.

> Damage to or destruction of the sensor

Protect cables from damage.

> Damage to the sensor, failure of the measurement device

Avoid permanent accumulation of dust or splashed water on the measurement system. Keep the optics clean by blowing them off, if necessary, or use a protective housing.

> Damage to light source and receiver

Avoid damage (scratches) to the protective windows of the light source and receiver by using proper cleaning methods or cleaning solvents. Do not touch the protective windows of the light source and receiver with the fingers. Wipe off any fingerprints immediately.

> Inaccurate, false measurements

## Notes on Product Marking

The product meets the requirements of CE and UKCA. All specifications described in the operating instructions must be observed.

## Unpacking, Included in Delivery

- 1 optoCONTROL 120x sensor, consisting of light source and receiver
- 2 Laser labels (1 x for Germany, 1 x for EU region and USA)
- 1 Assembly instructions

## LED's, Potentiometer

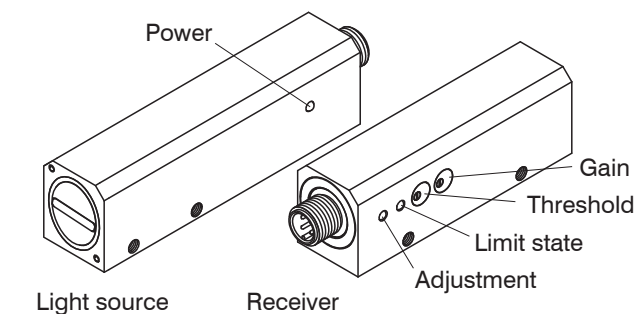

LED	Potentiometer	State	Description
Adjustment		Red	Output < 9.5 V
		Green	Output > 9.5 V
Use the gain pot to adjust the analog output up to 10 V.			
Limit state		Yellow	Analog voltage < threshold value
		Green	Analog voltage > threshold value
Threshold	Gain		Turn clockwise to increase threshold value, range 0 ... 10 V
			Turn clockwise to increase gain value, range 0 ... 10 V

LEDs, potentiometer, example optoCONTROL 1200

## Elektrical Connections, Power Supply and Output Cable

The supply voltage is preferably connected via a shielded cable, e.g. via the signal and power supply cable PC1200-x.

- ▶ Connect the cable shield to a ground terminal in close proximity to the power supply unit.

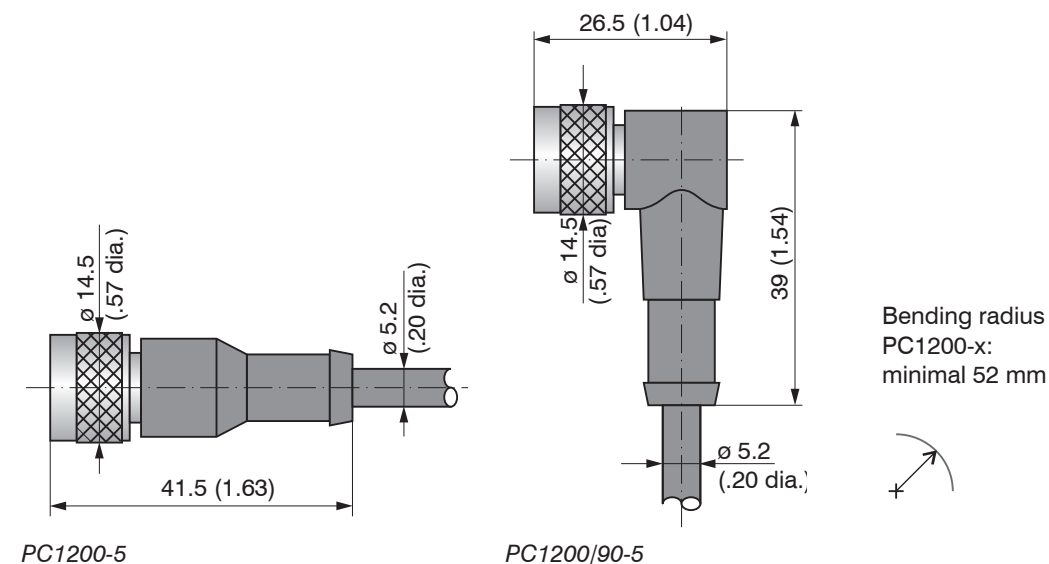

PC1200-5

PC1200/90-5

## Getting Ready for Operation

- ▶ Install and assemble the light source and the receiver in accordance to the mounting instructions, see operating instructions, Chapter 5.
- ▶ Connect the system, e.g., to a PLC or downstream display and monitoring units, and to the power supply, see operating instructions, chapter 6.

The laser diode is active if the power supply is on. To be able to produce reproducible measurements the sensor typically requires a start-up time of 1 minute. Once this has elapsed the sensor will be in measurement mode.

## Supply Voltage

Nominal value: 24 VDC (12 ... 32 VDC, max. 100 mA).

- ▶ Use an error-free and stabilized power supply unit.

MICRO-EPSILON Eltrotec GmbH recommends using an optional available power supply unit PS2020 for this sensor.

- ▶ Use the power supply only for measuring devices; do not use it at the same time for drives or similar sources of impulse interference to avoid noise and interference.

## Inputs and Outputs

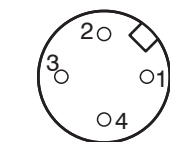

4-pin. female cable connector, view on solder pin side

### Light source

Pin	Signal	Color PC1200-x
1	+12 ... +32 VDC	Brown
2	Laser control	White
3	GND (0 V)	Blue
4	GND (0 V)	Black
Screen	Housing	- - -

### Receiver

Pin	Signal	Color PC1200-x
1	+12 ... +32 VDC	Brown
2	Analog output (0 ... 10 VDC)	White
3	GND (0 V)	Blue
4	Digital output	Black
Screen	Housing	---

### Laser power:

The laser power in the light source can be controlled.

Pin 2 open: 66 % of the maximum laser power

Pin 2 connected with GND: Full laser power

Pin 2 connected with 0 ... 5 VDC: Controls the laser power

Pin 2 connected with 5 ... 24 VDC: Laser off

- ▶ MICRO-EPSILON Eltrotec GmbH recommends the use of the signal and power supply cable PC1200-x. This cable is an optional accessory.

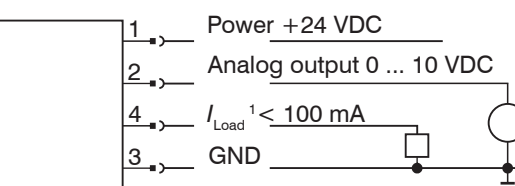

Receiver wiring, load connected to GND, (PNP active light quantity < threshold)

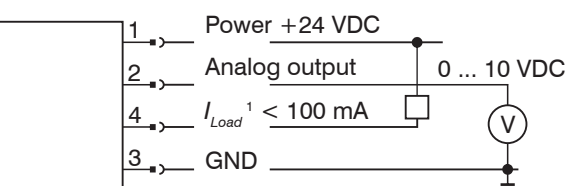

Receiver wiring, load connected with +24 VDC, (NPN active light quantity > threshold)

- 1) High side/low side side switch. The load can be connected to +24 VDC or to GND.

## Quick Guide

### IF1032/ETH

We recommend you use the optionally available IF1032/ETH interface module to convert the MICRO-EPSILON internal sensor protocol (RS485) to Ethernet or EtherCAT.

It offers three analog inputs (2 x 0 - 10 V voltage, 1 x 4 - 20 mA current) which can be used to convert the measured values from analog sensors such as the ODC1200 to Ethernet/EtherCAT.

### Features:

- three analog inputs, with adjustable sampling frequency of 2 sps - 4 ksp/s and trigger function
- Ethernet interface
- EtherCAT interface

- ▶ The two analog voltage inputs 0 - 10 V can be used for the ODC120x. Please consider the maximum sampling frequency.

## sensorTOOL

Sensor search and data acquisition are via the sensorTOOL program, parameter setting is via the website.

In order to save measured data in a csv file, use the sensorTOOL program.

The sensorTOOL program gives you a documented software that can be used for setting the sensors, for demonstration purposes, or for quick visualization of the measurement data.

The sensorTOOL program is available online at <https://www.micro-epsilon.de/download/software/sensorTool.exe>.

- ▶ Start the sensorTOOL program.

- ▶ In the drop-down menu, select the Interfaces sensor group, and for Sensor type, select IF1032/ETH.

- ▶ Click on the button with the magnifying glass icon.

All available channels will now be displayed in the Search Results (x) overview.

sensorTOOL 1.9.0.57

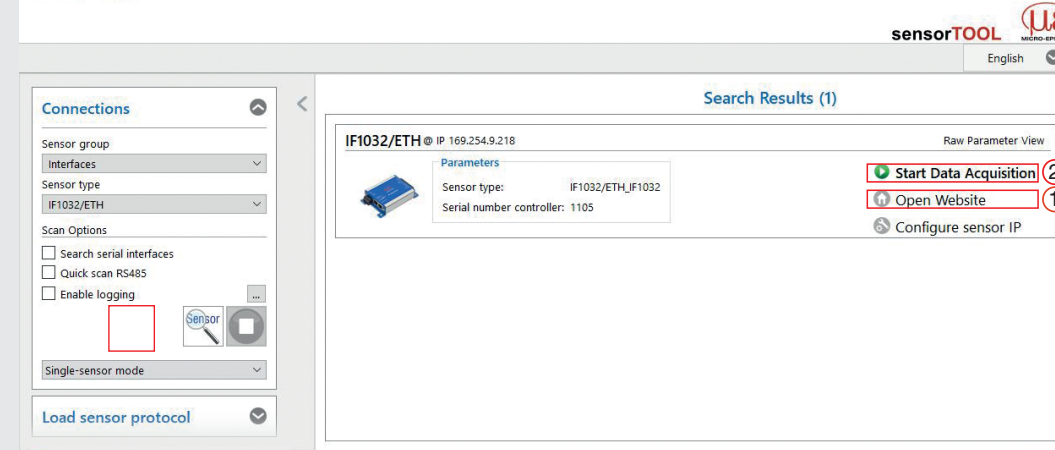

First interactive site after calling the sensorTOOL

- ▶ Click on the button Open Website (1), to make further settings and then Start Data Acquisition (2) in the sensorTOOL to start data acquisition, see operating instructions, Chapter I A 3.

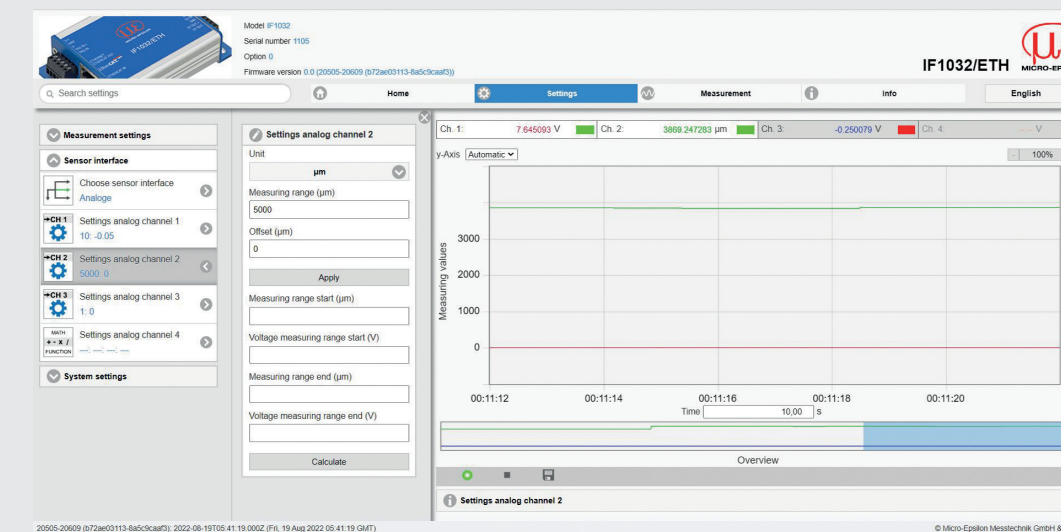

In the top navigation bar, other functions (settings, measurement chart etc.) are available. The appearance of the websites depends on the functions. Each page contains parameter descriptions and tips on completing the web page.

You can find more information about the sensor in the operating instructions. They are available online at:

<https://www.micro-epsilon.com/download/manuals/man--optoCONTROL-1200--de-en.pdf>

or with the QR code at right:



MICRO-EPSILON Eltrotec GmbH  
 Manfred-Wörner-Straße 101 • 73037 Göppingen / Germany  
 Tel. +49 (0)7161 98872-300 • Fax+49 (0)7161 98872-303  
 eltrotec@micro-epsilon.com • www.micro-epsilon.com  
 Your local contact: [www.micro-epsilon.com/contact/worldwide/](http://www.micro-epsilon.com/contact/worldwide/)