



# More Precision

**surfaceCONTROL** // Inspection of diffusely reflecting surfaces





**Requirements**

High quality finished surfaces are a challenge for many areas of industry. As well as in the automotive industry, these challenges are present in domestic appliances, entertainment devices and living accessories. The perceived quality of smooth, defect-free surfaces is determined by the feel of the surface, the color and a uniform surface appearance. Even the smallest of defects that are visible under special lighting conditions can disturb the overall impression.

As well as the visual demands, there are technical needs too, which require an immaculate surface. One example is the evenness of faces, which guarantees a save fit across the entire surface of the components.

**Tolerances of the components are larger than the defects that are to be detected**

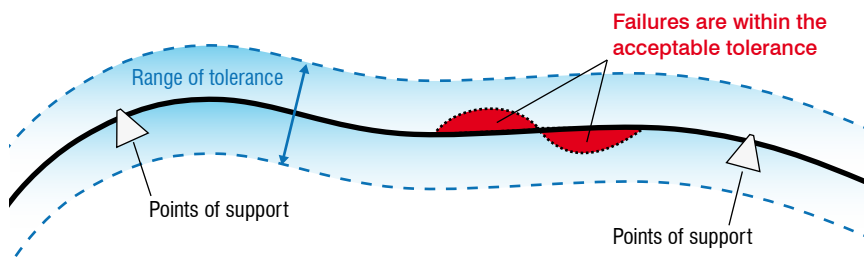

**When inspecting the surfaces, there are two primary challenges:**

1. Experienced auditors see a large proportion of the defects reliably and quickly. Visual evaluation, however, is often subjective and highly depends on several factors. Processes are required that enable an objective, reproducible evaluation of the defect or failure, and so help to make reliable decisions quickly.
2. The defects have a height/depth which often is significantly smaller than the geometrical tolerance of the components. In comparison with a CAD data record, the geometrical tolerances become visible; the smaller, local failures cannot be seen.

**Typical types of failure / inspection characteristics**

Bumps – dents – pimples – drag marks – waves – pockmarks – neckings – edge detection – impact lines – cracks – contraction – distortion – evenness – shape – completeness

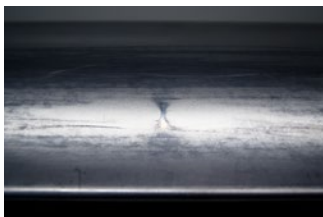

Pimples

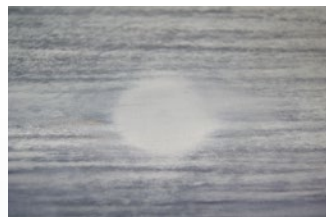

Drag marks



Neckings



Waves

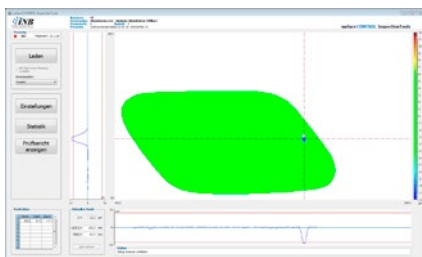

Defect analysis with surfaceCONTROL InspectionTools

The surfaceCONTROL product line was designed specifically for the inspection of diffusely reflecting surfaces, e.g. metallic surfaces (uncoated, electroplated, EPD), plastic surfaces and ceramics.

The sensor based on the fringe projection principle scans the surface and generates a 3D point cloud of this surface. Therefore a sequence of structured light pattern is projected on the surface. The calibrated cameras use this pattern for searching corresponding points, from which the 3D data is calculated. Sensors with different measurement areas and resolutions are available.

The surfaceCONTROL Inspection Tools software offers recognition of the smallest defects and errors on the surface. There are different options to find and evaluate the deviations in the 3D-point cloud, from which the optimal process is chosen according to the corresponding inspection tasks. The calculation of the 3D data and the data analysis is made with an industrial PC.

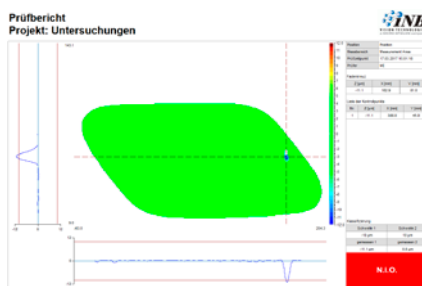

Evaluation protocol as a report

#### Advantages of the INB systems

- Detecting surface shape defects
- Objective evaluation of the defects (OK-/NOK-decision)
- Clear definition of the failure criteria in supplier relations
- Increasing the testing frequency allows for continuous process control
- Minimizing reconditioning costs and reject costs
- Optical error marking on the component with back projection



Door component

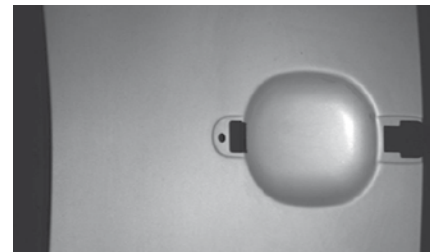

Door handle

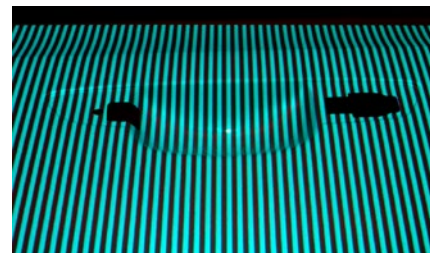

Fringe projection

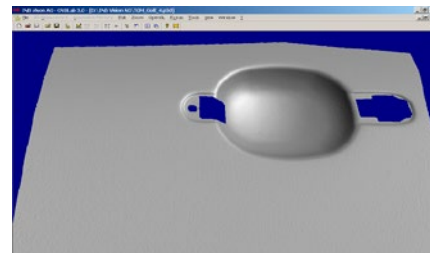

3D point cloud

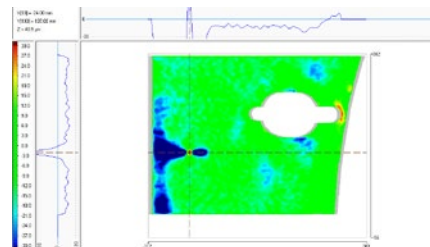

Result of digital stone

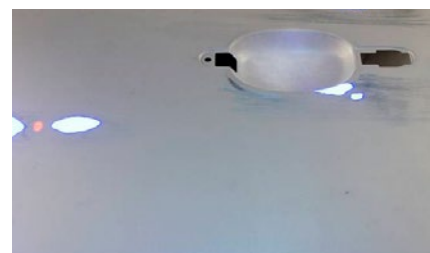

Back projection of the controlling result onto the component

### Inspection of car body components

One of the main application fields of surface inspection system is the identification and analysis of deformations and discontinuity in automotive body shell parts. In modern stamping lines, automotive body shell parts are produced in a cycle time of a few seconds. The processes which have to be controlled are very complex and require lots of experience. Because of the different fouling, material tolerances or variations in the process, unwanted shape defects such as pimples, bumps, dents and neckings may appear.

A visual recognition of these defects on metallic surfaces is almost impossible. For production release and after defined time intervals (0.5 – 1h) such components are chosen, whose surface is completely checked by physically feeling or pulling with a stone.

This process is highly complex and contains the risk of not recognizing failures. With every step in the manufacturing process the value of the components and the effort involved in reconditioning increases. In-process detection and retraction of the failures helps to minimize quality costs.

With the surfaceCONTROL product line INB has developed a system that scans the surface of the car body components with a 3D sensor in a few seconds and offers the detection and evaluation of local defects.

A digital stone, for example, is used for the analysis. This block is moved over the 3D-data of the surface like a physical block. The length and direction of the block is adjusted according to the shape of the surface.

The result is the DefectMap; a graphical representation of the defect with exact information about the height and depth. The determined values can be used for an automatic OK/NOK-decision.

All body shell parts made of metal are inspected; beginning with the pressing machine to the assembly line, the body in white to the EPD coating. The sensor can be mounted to a robot for the inspection of body components.

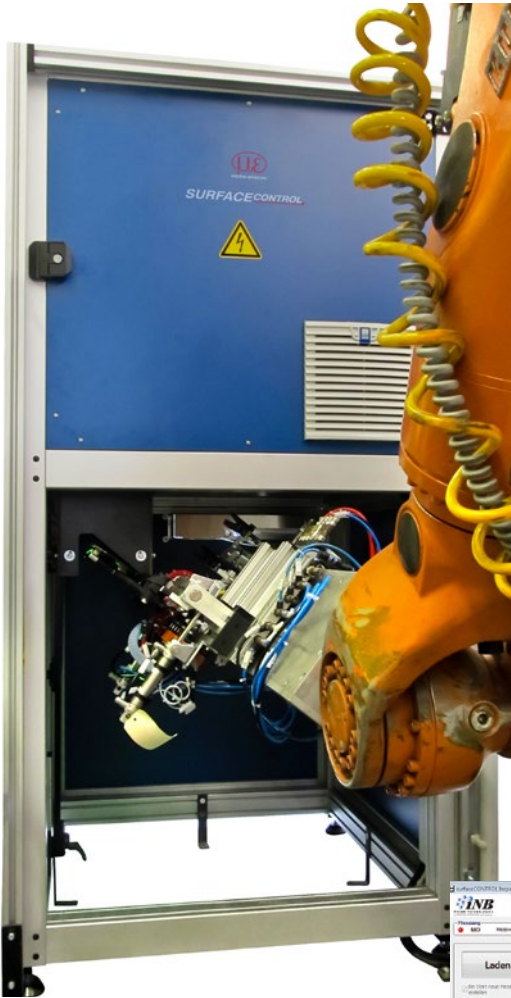

### Inspection of exterior plastic parts

In recent years, the use of plastics has increased in vehicle design, as is the case with the outer skin.

#### Examples:

- Injection molded components such as car fender, fuel doors or covers on doors or sliding roofs
- Composite parts (SMC) such as boot lids or spoilers

The surfaceCONTROL inspection systems recognize and evaluate the shape deviation on these components and help to reduce the quality costs and to avoid waste or rework.

These systems recognize relevant deviations from 5 ... 50 $\mu\text{m}$  (depending on the surface) typically within a few seconds (0.5 ... 2.0s), and evaluate them objectively. Even the slide marks of the bolt with a height of about 1 $\mu\text{m}$  can be recognized.

The surfaceCONTROL inspection systems can be used in different stages:

- Development up to the first prototype
- Tool and die manufacturing
- Series production start-up
- Series supervision (sample checks or 100% inspection)
- Inspection of quality of already produced or bought-in components

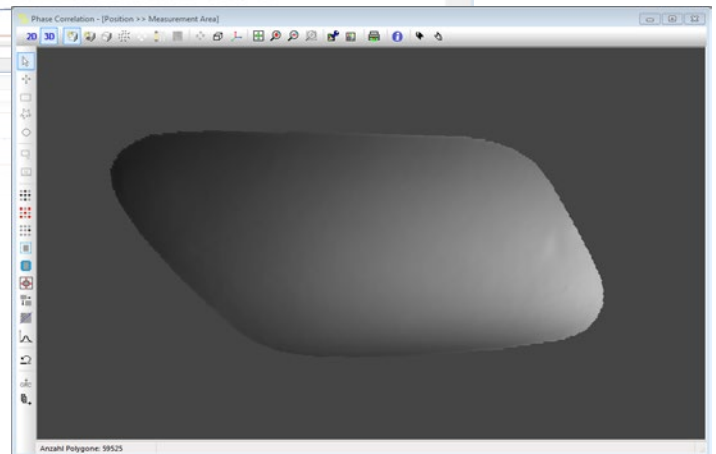
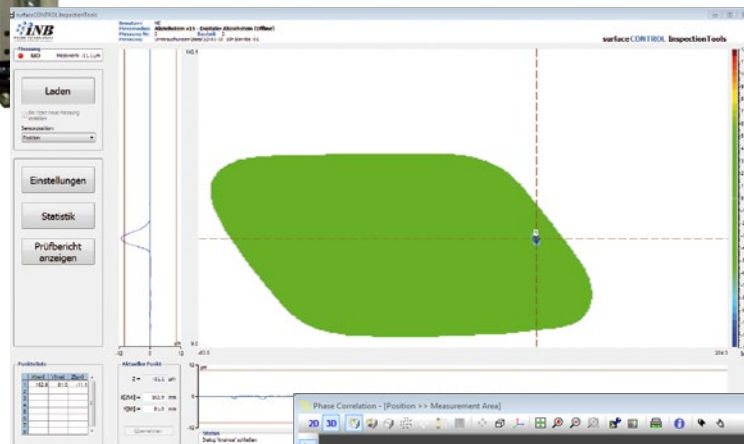

**Inspection of interior plastic parts**

The overall impression of a vehicle's quality is strongly influenced by its interior. This is why high quality materials, tight manufacturing tolerances and the perfect assembly of interior components are critical. One key aspect is the control panel and dashboard, which can always be seen by the front seat passengers.

As well as the visual requirements, functional and security requirements also have to be fulfilled. For this reason, the passenger airbag has a predetermined breaking line which is generated using a laser. This "weak point" ensures the safe opening of the airbag at the predetermined breaking line.

Due to the heat input when fixing the airbag in place, or because of the mechanical pressure of the control panel, sink marks may appear, which can be recognized under certain light conditions. Furthermore, welded components on the bottom side of the control panel such as the ventilation duct, airbag module, glove compartment etc. may lead to visible undulations on the surface.

The surfaceCONTROL systems enable fast, objective evaluations to be made of the characteristics of any shape deviations, both on grained and smooth surfaces.



surfaceCONTROL mobile 3D sensor  
Inspection of the control panel in the vehicle



Passenger airbag  
Inspection of grained surface

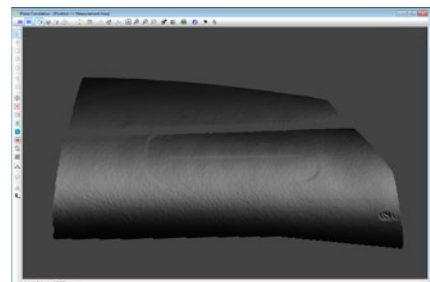

3D view with Black Paint Simulation  
Visual evaluation of airbag profile

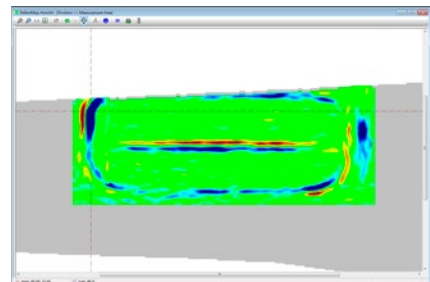

Result of digital stone  
Objective assessment of airbag profile



Full-surface back projection  
of the inspection result

### surfaceCONTROL DefMap3D for individual surface analysis

surfaceCONTROL DefMap3D is the most comprehensive software solution for the detection and analysis of surface defects. It includes all components and processes required for set up, configuration and evaluation of inspection tasks.

Its range of features ensures that surfaceCONTROL DefMap3D can deal with a wide variety of tasks, from single parts analysis and small series measurements to robot-assisted inspection of multiple measuring fields. Sensor control, calculation of the 3D point cloud and defect detection can be automated using macro commands.

As part of the surface analysis, the software provides several methods of detecting and objectively evaluating shape errors within the surface data. In addition, it is possible to virtually tint the surface data black to get a visual impression of surface deviations on the display. The targeted use of different filter types can reduce the effects of surface structures (e.g. graining).

A report containing the inspection results is generated.

surfaceCONTROL DefMap3D is available in different versions. Therefore, the scope of performance can be optimally adapted to the requirements of the respective measurement task.

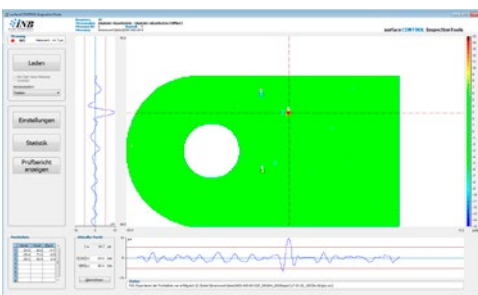
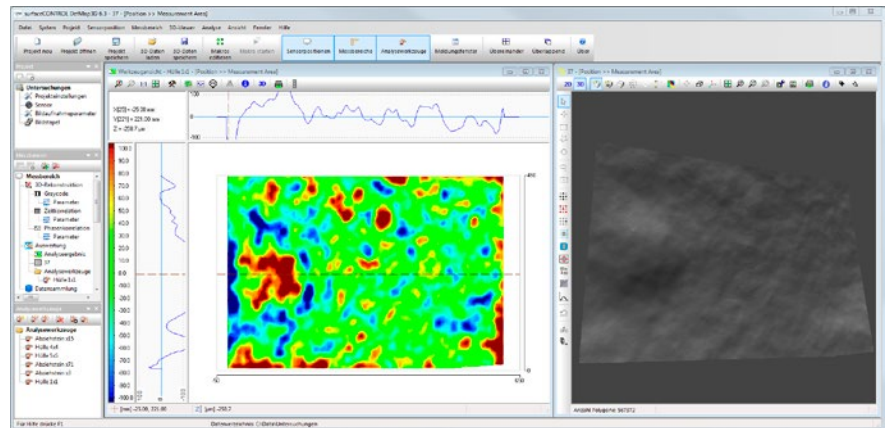

### surfaceCONTROL InspectionTools for automated inspection

The software is based on a modular concept that accurately reflects the required amount of tools for each inspection task. The software uses a communication interface to communicate with master control devices, for example to start measurements or output OK/NOK decision.

The lean software provides accurate functionality and a reliable operation of the measurement system. A user management feature defines different access levels. The captured data is recorded to ensure long-term quality monitoring and traceability of results.



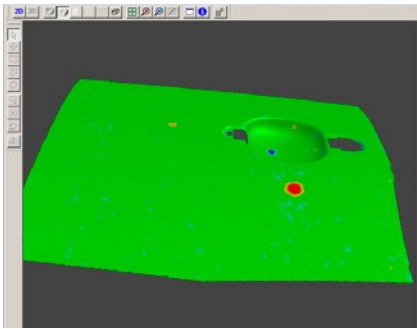

**Digital Master**

In the first step, the parts are chosen, which are accepted as OK by the customer. The surfaces of these components are captured with the surfaceCONTROL 3D sensor. The parameters of acceptable surface forms are calculated via the generated 3D-data and archived in an associative memory. Behind this is a neuronal network, which is trained with the data. In the inspection process the surface data of the object to be inspected is first captured with the sensor. Afterwards the software reconstructs the object based on the trained data and calculates an individual master. Then it is compared against this master. When there are no differences between the calculated master and the part that is controlled, the part is flawless. Deviations are shown in a DefectMap. This process is ideally suited to series control.

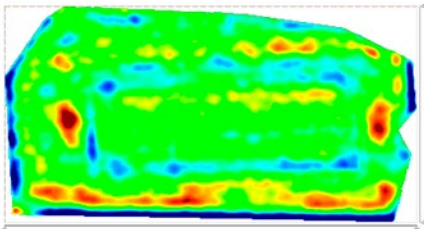

**Digital shape**

The 3D data of the surface is described by a set of mathematical functions using two dimensional polynomial approximation. Depending on their degree, the polynomials have the ability to adapt the shape of the surface like an envelope. The 3D data is compared against the calculated envelope and possible deviations in the surface are identified as defects. The digital shape evaluation is suited for fast analysis of flat and slightly curved surfaces.

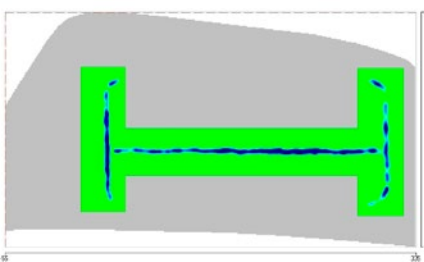
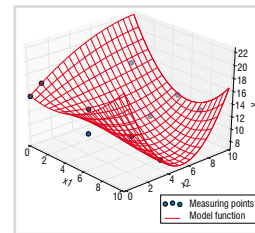
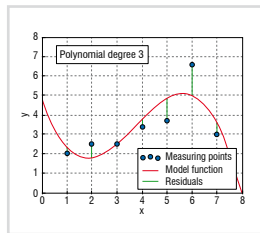

**Digital stone**

The digital stone is used on the previously captured 3D data directly. During this process the software is looking for the two highest points (point of support) along a line segment. Afterwards the gaps between the line segment and the 3D-data are calculated. It is mainly used in the analysis of defects in the toolmaking process as well as in pre-production series.

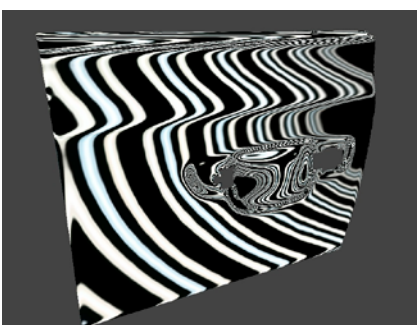
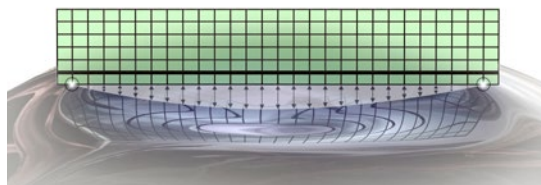

**Digital light tunnel**

It can be very difficult to detect very small local deviations on tested components, in particular on matt surfaces. It is common practice, for example, to paint vehicle body parts in glossy black and inspect under special lighting, such as a light pipe, in order to get a visual impression of a defect's geometric form. This process cannot be used for all surfaces, it requires additional time and material, and the components cannot be used afterwards. This is why surfaceCONTROL offers the possibility to impose defined characteristics (color, glossy finish) onto the captured 3D surfaces and inspect them on the monitor either under diffuse lighting or with a light bar. So without any additional material even the smallest defects become visible and can be assessed visually.

Model	surfaceCONTROL2500	-360	-500	-720
Measurement area x-/y- axis (length / width)	Measurement area (close)	260 x 190mm <sup>2</sup>	350 x 260mm <sup>2</sup>	500 x 375mm <sup>2</sup>
	Measurement area (center)	300 x 220mm <sup>2</sup>	400 x 300mm <sup>2</sup>	575 x 435mm <sup>2</sup>
	Measurement area (far)	340 x 250mm <sup>2</sup>	450 x 340mm <sup>2</sup>	650 x 495mm <sup>2</sup>
	Resolution	≥ 0.25mm	≥ 0.3mm	≥ 0.5mm
Measuring range z-axis (height)	Start of measuring range	475mm	660mm	950mm
	Midrange	550mm	760mm	1100mm
	End of measuring range	625mm	860mm	1250mm
	Height of measuring range	150mm	200mm	300mm
Interfaces	Gigabit Ethernet		Image output	
	USB 2.0		Sensor control	
Light source	/BL		LED, 462nm (blau)	
	/GR		LED, 528nm (grün)	
	/RD		LED, 612nm (rot)	
Pattern frequency	Sequence (typ.)		up to 2Hz	
Protection class	Sensor		IP40	
Operating temperature			5°C to 40°C	
Storage temperature			-10°C to 50°C, non-condensing	
Dimensions			626 x 290 x 144 mm <sup>3</sup>	
Weight sensor	without cable		7.0kg	
Supply			18-24 VDC, 150W	

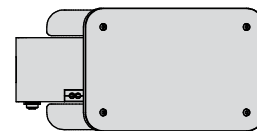
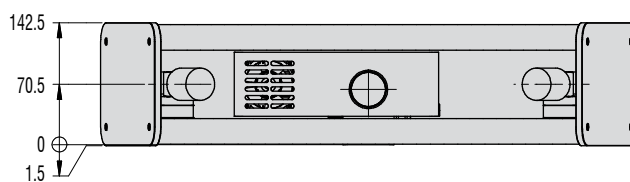
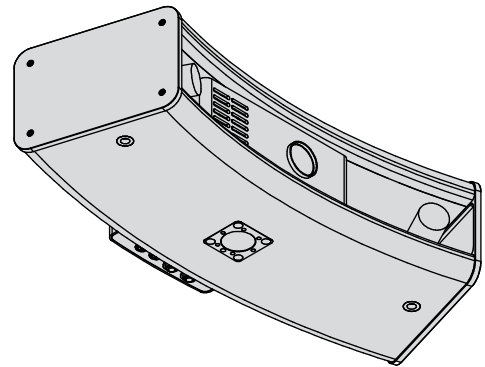
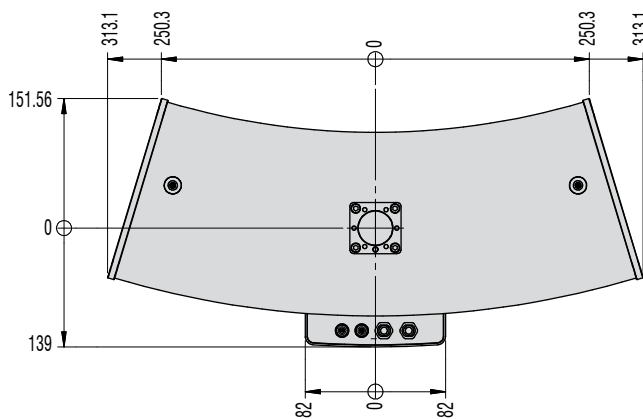

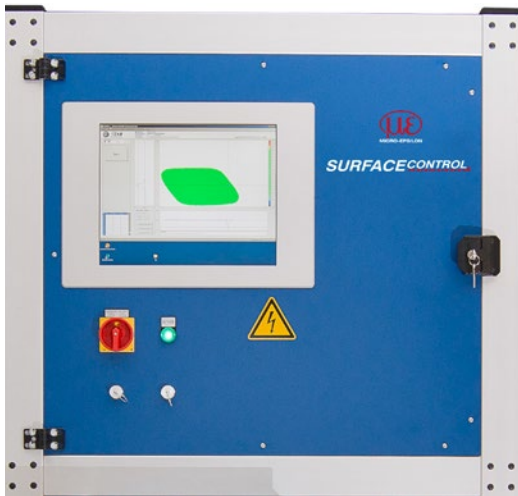

#### surfaceCONTROL Compact

The system surfaceCONTROL Compact is available for the inspection of small test pieces up to about 200mm x 150mm. The sensor is permanently integrated into a housing. Amongst other things, surfaceCONTROL Compact is suitable for the inline inspection of injection molding and die cast metal components.

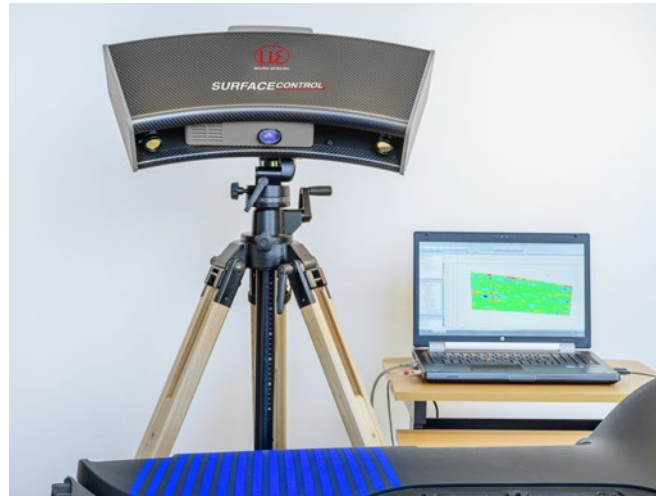

#### surfaceCONTROL Mobile

For the inspection of the surface of components in different places, surfaceCONTROL Mobile is the ideal solution. The portable system, which consists of a laptop and a sensor, can be safely transported in a carry case. It can be mounted on a tripod. The standard measuring area is about 400mm x 300mm



#### surfaceCONTROL Robotic

When mounting the sensor to a robot, the system can be quickly and easily adapted to different measurement tasks. Six degrees of freedom of the robot are available. According to the requirements, a robot with a certain dimension can be chosen.

If the component is positioned on a rotary table as seventh axis, it can be turned towards the sensor reducing the required outreach of the robot. Due to surfaceCONTROL Robotic large components can undergo a complete inspection.



#### Micro-Epsilon systems for the inspection of reflecting surfaces:

- reflectCONTROL Sensor
- reflectCONTROL Automation
- reflectCONTROL Automotive

## Sensors and Systems from Micro-Epsilon



Sensors and systems for displacement, distance and position



Sensors and measurement devices for non-contact temperature measurement



2D/3D profile sensors (laser scanner)

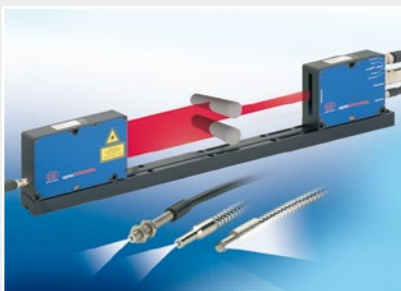

Optical micrometers and fiber optics, measuring and test amplifiers



Color recognition sensors, LED analyzers and inline color spectrometers



3D measurement technology for dimensional testing and surface inspection