









# More Precision.

**optoNCDT ILR** // Laser-optical distance sensors



# Compact and reliable laser distance sensor optoNCDT ILR 103x/LC1

-  Measuring range up to 15 m  
(with reflector 50 m)
-  Ideal for series applications  
automation
-  Laser class 1
-  Robust design IP67
-  Fast response time
-  Compact & lightweight design



The ILR103x/LC1 laser distance sensors operate according to the time-of-flight technology. Based on this technology, these sensors provide accurate, reliable and unambiguous as well as reproducible measurement results regardless of ambient conditions such as surface properties, dark colors or ambient light. The sensors use a measuring laser with laser class 1.

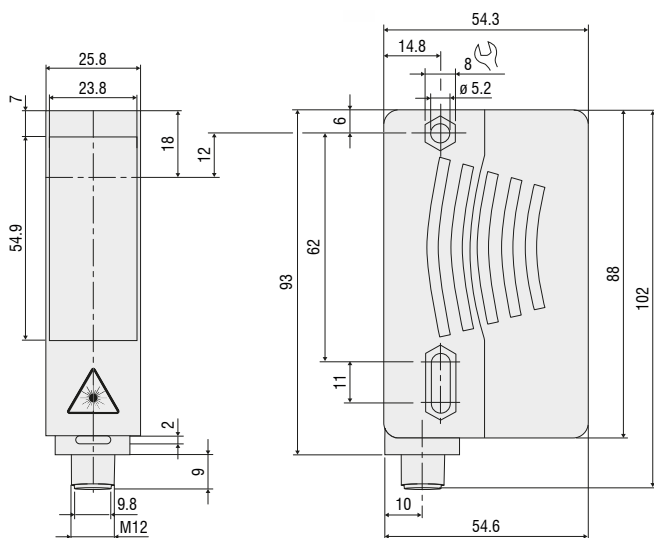

(dimensions in mm, not to scale)

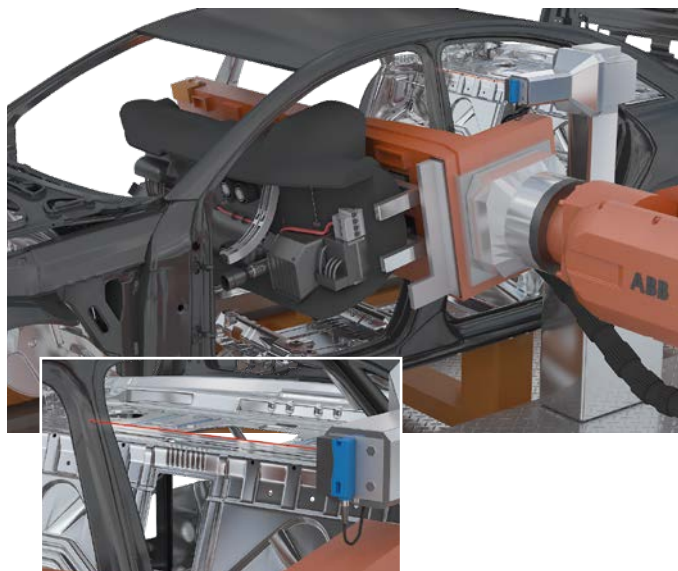

optoNCDT ILR1030-8/LC1  
Distance measurements in robot positioning tasks



Model	ILR1030-8/LC1		ILR1030-15/LC1		ILR1031-50/LC1		
Article number	7112011.01		7112013.01		7112012.01		
Measuring range <sup>1)</sup>		SMR	EMR	SMR	EMR	SMR	EMR
	black 10 %	0.2 m	2.5 m	0.2 m	5 m	-	
	gray 18 %	0.2 m	3.5 m	0.2 m	6 m	-	
	white 90 %	0.2 m	8 m	0.2 m	15 m	-	
	Reflector film <sup>2)</sup>	-		-		0.2 m	50 m
Measuring rate	100 Hz						
Resolution	1 mm						
Linearity <sup>3)</sup>	±25 mm						
Repeatability	<5 mm						
Temperature stability	≤ 0.25 mm / K						
Light source	Semiconductor laser < 1 mW, 660 nm (red)						
Laser class	Class 1 in accordance with DIN EN 60825-1:2007						
Typ. service life	85,000 h						
Permissible ambient light	50,000 lx						
Supply voltage	10 ... 30 VDC						
Power consumption	< 1.5 W (24 V)						
Analog output	4 ... 20 mA, short circuit- and overload-proof, (12 bit D/A, max. load 500 Ohm)						
Switching output	Q1/Q2 push-pull outputs (configurable)						
Connector	Supply/signal: 4-pin M12 screw/plug connection (see accessories for connection cable)						
Assembly	Through bores						
Temperature range	Storage	-30 ... +70 °C (non-condensing)					
	Operation	-30 ... +55 °C (non-condensing)					
Shock (DIN EN 60068-2-27)	25 g / 6 ms in 3 axes						
Vibration (DIN EN 60068-2-6)	2 g / 10 ... 2000 Hz						
Protection class (DIN EN 60529)	IP67						
Material	Plastic housing ABS, plastic pane						
Weight	90 g						
Control and indicator elements	1x LED for power, 1x LED for switch signal 5-step rotary switch for the selection of switching thresholds and analog scaling Button for setting the switching threshold and analog scaling length 660 nm						
Special features	-						

SMR = Start of measuring range, EMR = End of measuring range

The specified data apply for a consistent room temperature of 20 °C, sensor is continuously in operation. Measured on white, diffuse reflecting surface (reference ceramic)

<sup>1)</sup> Depends on the reflectivity of the target, ambient light interference and atmospheric conditions

<sup>2)</sup> ILR-RF250 reflector film 250 x 250 mm; article no: 7966001

<sup>3)</sup> Statistical spread 2  $\sigma$

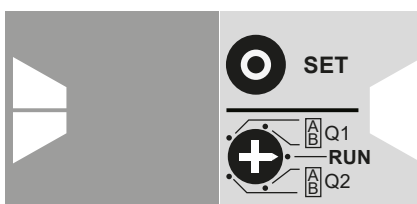

ILR103x: Adjust analog output and switching output via touch keys







#### Spot diameter ILR103x/LC1



The ILR103x/LC1 sensors use a semiconductor laser of class 1. Devices of this laser class require no special safety precautions. They work with a semi-conductor laser with a wavelength of 660 nm (visible/red). Laser power is <1 mW.

# Accessories optoNCDT ILR

## Accessories optoNCDT ILR103x/LC1







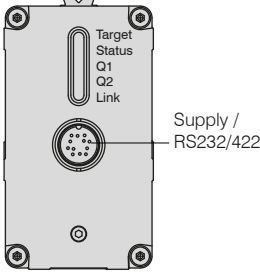

Connection	Interface modules	Connection cables	Sensor	Accessories
Supply/PLC Power supply unit PS2031 Art. no.: 2420096 		Supply and output cable Art. no.: 2901232 (2 m) 2901233 (2 m, 90°) 2901234 (5 m) 2901235 (5 m, 90°) 2901268 (10 m, 90°) 29011248 (10 m)		Reflector 250 x 250 mm Art. no.: 7966001 
Digital output/Ethernet 	IF1032/ETH Art. no.: 2420066 			

## Accessories optoNCDT ILR2250-100 / ILR2250-100-H / ILR2250-100-IO

Connection	Interface modules	Connection cables	Sensor	Accessories
Supply/PLC Power supply unit PS2031 Art. no.: 2420096 		Supply and output cable Art. no.: 2901524 (3 m) 2901239 (3 m, 90°) 2901573 (5 m) 2901240 (5 m, 90°) 2901236 (10 m) 2901241 (10 m, 90°) 2901237 (20 m) 2901242 (20 m, 90°) 2901238 (30 m) 2901243 (30 m, 90°)	ILR2250-100 ILR2250-100-H 	Reflector 210 x 297 mm Art. no.: 7966058 
PLC Ethernet 	IF2030 for PROFINET Art. no.: 2420087  IF2030 for EtherNet/IP Art. no.: 2420088 			
Digital output/Ethernet 	IF2001/USB Art. no.: 2213025 			Air purge collar Art. no.: 7966062 
	IC2001/USB Art. no.: 2213041 			Protective glass Art. no.: 7966061 
	IF1032/ETH Art. no.: 2420066 			Filter glass Art. no.: 7966063 ILR-NDF 0.75 7966066 ILR-NDF 0.5 7966068 ILR-NDF 0.9 
	IF2004/USB Art. no.: 2213024 	Art. no.: 29011342 (3 m) 29011347 (5 m) 29011348 (10 m) 29011372 (20 m) 2x 2901528 (0.3 m)		
PLC Ethernet 	IF2008/ETH for 8 sensors Art. no.: 2213030 	Art. no.: 29011107 (5 m) 29011398 (3 m) 		
	IO-Link master 	IO-Link standard cable Art. no.: 29011362 (5 m) 29011363 (10 m) 29011364 (15 m) 	ILR2250-100-IO Sensor + adapter cable (0.3 m)  	

# Accessories optoNCDT ILR

## Accessories optoNCDT ILR1 191-300

Connection	Interface modules	Connection cables	Assembly	Accessories
Supply/PLC Power supply unit PS2031 Art. no.: 2420096 		Supply and output cable Art. no.: 2901524 (3 m) 2901239 (3 m, 90°) 2901573 (5 m) 2901240 (5 m, 90°) 2901236 (10 m) 2901241 (10 m, 90°) 2901237 (20 m) 2901242 (20 m, 90°) 2901238 (30 m) 2901243 (30 m, 90°)	Electrical connections 	Reflector 250 x 250 mm Art. no.: 7966001 
Digital output/Ethernet 	IF2001/USB Art. no.: 2213025 			Mounting plate Art. no.: 7966014 
	IF1032/ETH Art. no.: 2420066 			Protection tube Art. no.: 7966016 
				Alignment aid Art. no.: 7966060 

## Sensors and Systems from Micro-Epsilon



Sensors and systems for displacement, position and dimension



Sensors and measurement devices for non-contact temperature measurement



Measuring and inspection systems for quality assurance



Optical micrometers, fiber optics, measuring and test amplifiers



Color recognition sensors, LED Analyzers and inline color spectrometers



3D measurement technology for dimensional testing and surface inspection